

THERMOTRON

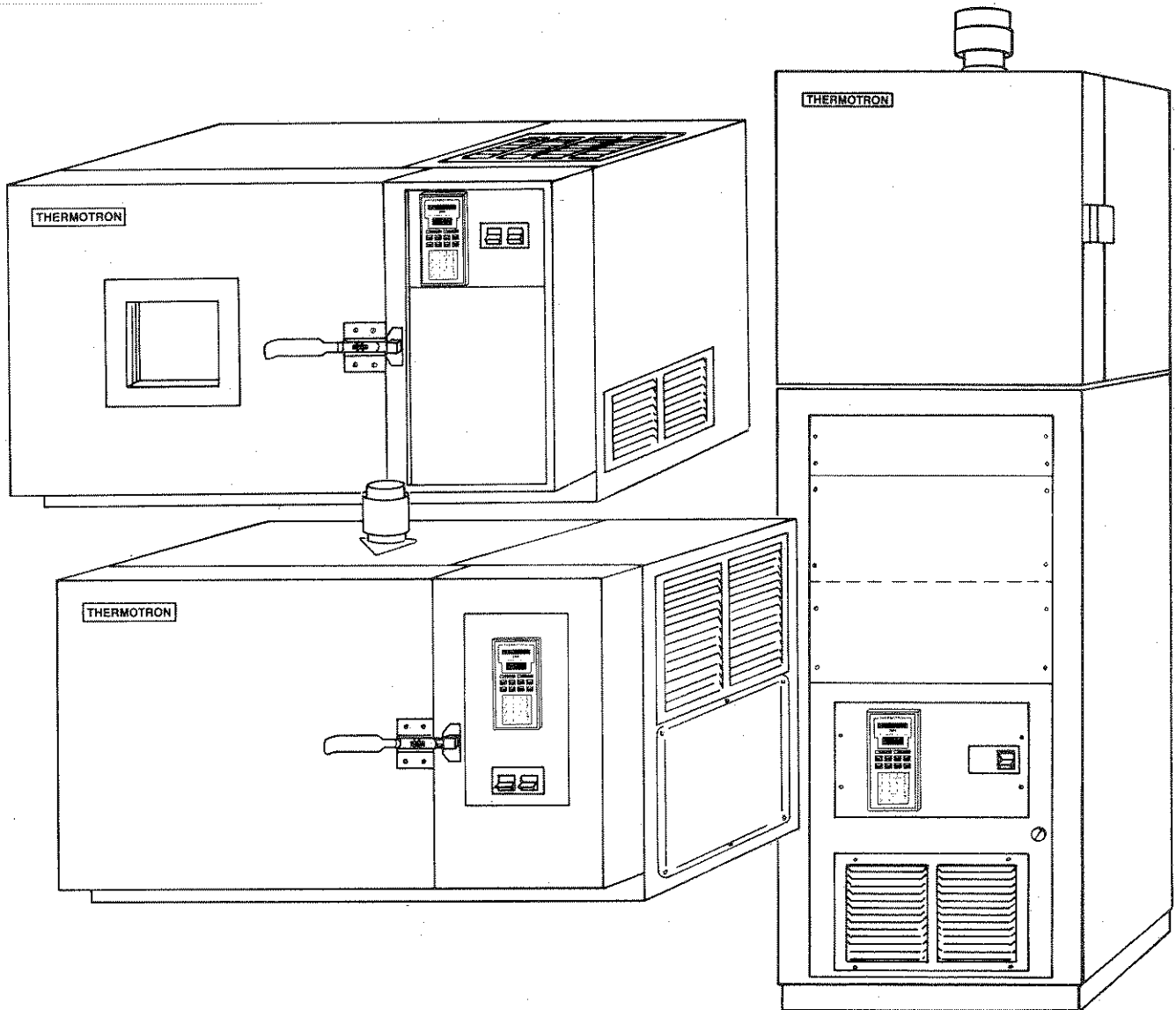

This manual has important information for the safe operation of this chamber. Read this manual carefully and tell all operators to read this manual. If you do not follow the instructions, you can cause an injury or damage to the equipment, the product, and the building.

TEMPERATURE CHAMBER MODELS: S1.2, S1.2V, and S5.5C OPERATOR MANUAL

For new manuals contact:

THERMOTRON INDUSTRIES, INC., 291 Kollen Park Drive, Holland, Michigan 49423 U.S.A.
Phone: (616) 392-1491 TWX 810-292-6164

TEMPERATURE CHAMBER
MODELS: S1.2, S1.2V, and S5.5C
TABLE OF CONTENTS

SAFETY INSTRUCTIONS	1
SPECIFICATIONS	2
TEMPERATURE CHAMBER MODEL S1.2	3
TEMPERATURE CHAMBER MODEL S1.2V	4
TEMPERATURE CHAMBER MODEL S5.5C	5
SECTION A: THE INSTALLATION	
How to Install the Chamber	A1
SECTION B: THE OPERATION	
The Controls	B1 and B2
How to Operate the Chamber	B3
How to Remove a Product from Test	B4
SECTION C: THE PREVENTIVE MAINTENANCE	
How to Clean the Condenser Fin Coils on Model S1.2	C1
How to Clean the Condenser Fin Coils on Model S1.2V	C2
How to Clean the Condenser Fin Coils on Model S5.5C	C3
How to Check the Pressure of the Refrigeration System on Model S1.2	C4
How to Check the R-13 Standby Pressure on Model S1.2V	C4
How to Check the R-13 Standby Pressure on Model S1.2V and Model S5.5C Equipped with Refrigeration Gauges	C5
How to Check the Refrigeration System on Model S5.5C Not Equipped with Refrigeration Gauges	C6
How to Check the Charge of the R-502 Refrigeration System on Model S5.5C	C7
How to Check the R-13 Standby Pressure on Model S5.5C Using a Refrigeration Gauge Manifold	C8 and C9

SECTION D: THE SERVICE

How to Replace the Heat Links on Models S1.2 and S1.2V D1 and D2
How to Replace the Heat Links on Model S5.5C D3
How to Charge the R-13 Refrigeration System on Model S5.5C D4 and D5
How to Charge the R-502 Refrigeration System on Model S5.5C D6 and D7

SECTION E: THE PARTS LIST AND THE DRAWINGS

The Recommended Spare Parts List E1
How to Return Materials E2













The Parts List

The Drawings

SECTION F: THE APPENDIX

SAFETY INSTRUCTIONS

For the safe operation of this chamber, read and understand all warnings and cautions. Look for these symbols:

-  **WARNING:** If you do not follow the instructions in a **WARNING**, injury can occur to you or to other personnel.
-  **CAUTION:** If you do not follow the instructions in a **CAUTION**, damage can occur to the equipment.
-  1. You must have training in the operation of this chamber before using it. **Read the instruction manual.**
 -  2. Do not operate this chamber unless it is completely assembled.
 -  3. Maintenance and service must be done by authorized personnel only. Make adjustments according to the specifications given in this manual.
 -  4. To prevent injury and damage, disconnect the electric power from the chamber before doing any maintenance or service to the chamber.
 -  5. Do not tip the chamber more than 45° without special instructions from the manufacturer.
 -  6. This equipment operates at extreme high and low temperatures. Human exposure to temperatures other than 24°C (75°F) can cause injury.
 -  7. If the chamber temperature exceeds the safe limits for the product being tested, remove power from the chamber and from the product on test. A Productsaver, or an equivalent device, is necessary to remove power from the product on test.
 -  8. Always use an electrical supply system with separate electrical ground conductors. For maximum protection against electric shock, use a circuit that is protected by a ground fault circuit interrupter.
 -  9. Use of LN₂ or CO₂ in a chamber can result in a lack of oxygen in and around the chamber and can cause death.
 -  10. When working with refrigerant, follow all the safety instructions on the container of refrigerant.
 -  11. Make sure all the labels, warnings, and cautions are fastened to the chamber. Order new labels from Thermotron Industries, Inc.

SPECIFICATIONS

	S1.2 and S1.2V	S5.5C
VOLTAGE ±10%	115/1/60	230/1/60 or 230/3/60
RECOMMENDED MINIMUM SERVICE AMPERES	1 phase 20 amperes	1 phase 40 amperes 3 phase 30 amperes
TEMPERATURE RANGE	-100° to +350°F -73° to +177°C	-90° to +350°F -68° to +177°C
TOLERANCE AT CONTROLLER THERMOCOUPLE WHEN CHAMBER IS STABLE	±2°F ±1.1°C	±2°F ±1.1°C
TEMPERATURE PULLDOWN FROM +75°F (+24°C)		
0°F (-18°C)	---	8 minutes
-20°F (-29°C)	---	12 minutes
-40°F (-40°C)	20 minutes	15 minutes
-65°F (-54°C)	30 minutes	22 minutes
-90°F (-68°C)	40 minutes	55 minutes
-100°F (-73°C)	45 minutes	Does not apply
TEMPERATURE HEAT UP FROM +75°F (+24°C)		
+230°F (+110°C)	18 minutes	13 minutes
+350°F (+177°C)	45 minutes	30 minutes
CAPACITY FOR HOLDING WATTS LIVE LOAD		
0°F (-18°C)	350 watts	750 watts
-40°F (-40°C)	250 watts	500 watts
-65°F (-54°C)	200 watts	400 watts
-85°F (-65°C)	150 watts	300 watts

The above specifications are based on 60 hertz operation and +27°C (+80°F) ambient air. For 50 hertz operation, refrigeration and air flow performance are approximately 17% less. Accessories can reduce chamber performance.

TEMPERATURE CHAMBER MODEL S1.2

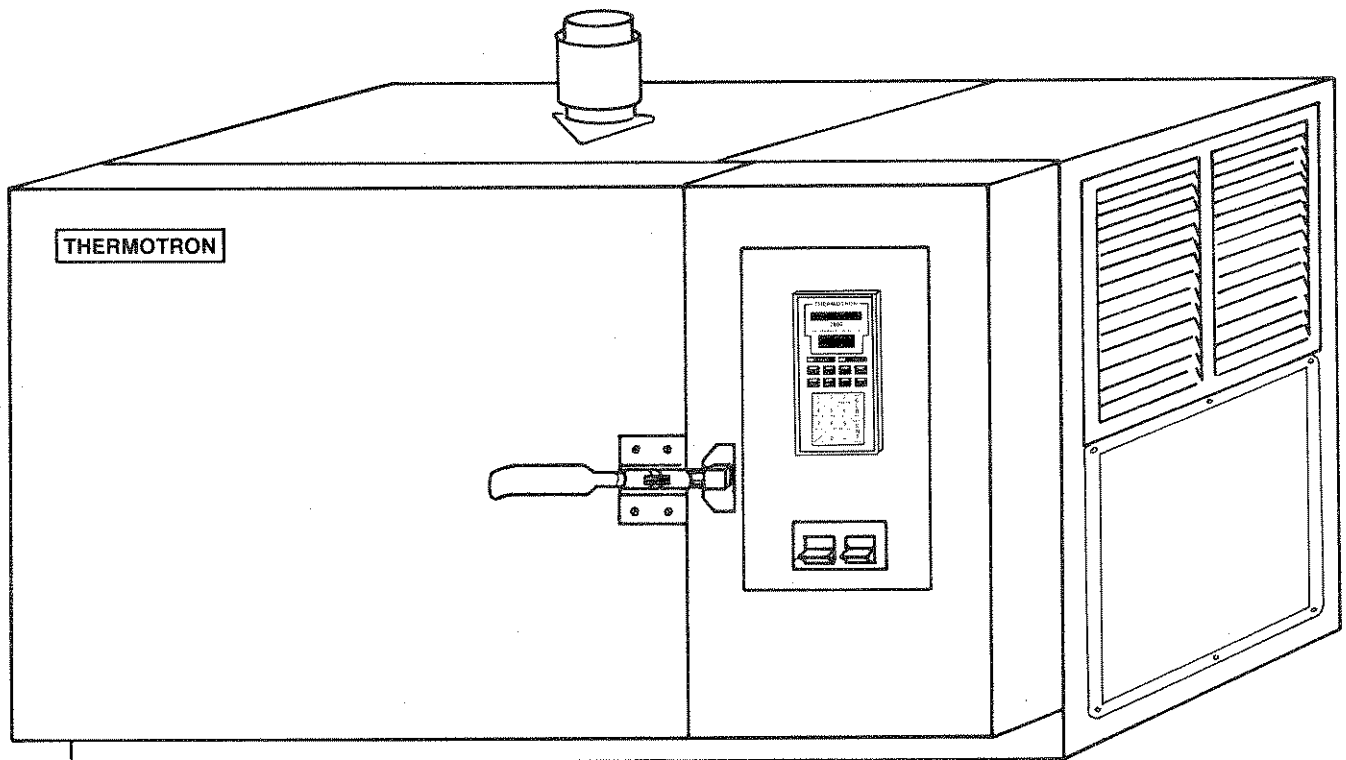

Model S1.2 is a bench top chamber designed to test temperature tolerances. This chamber has an interior size of 1.2 cubic feet. Model S1.2 can be equipped with various options. See the Option Sheet in the front of the manual to know which options your chamber has.

TEMPERATURE CHAMBER MODEL S1.2V

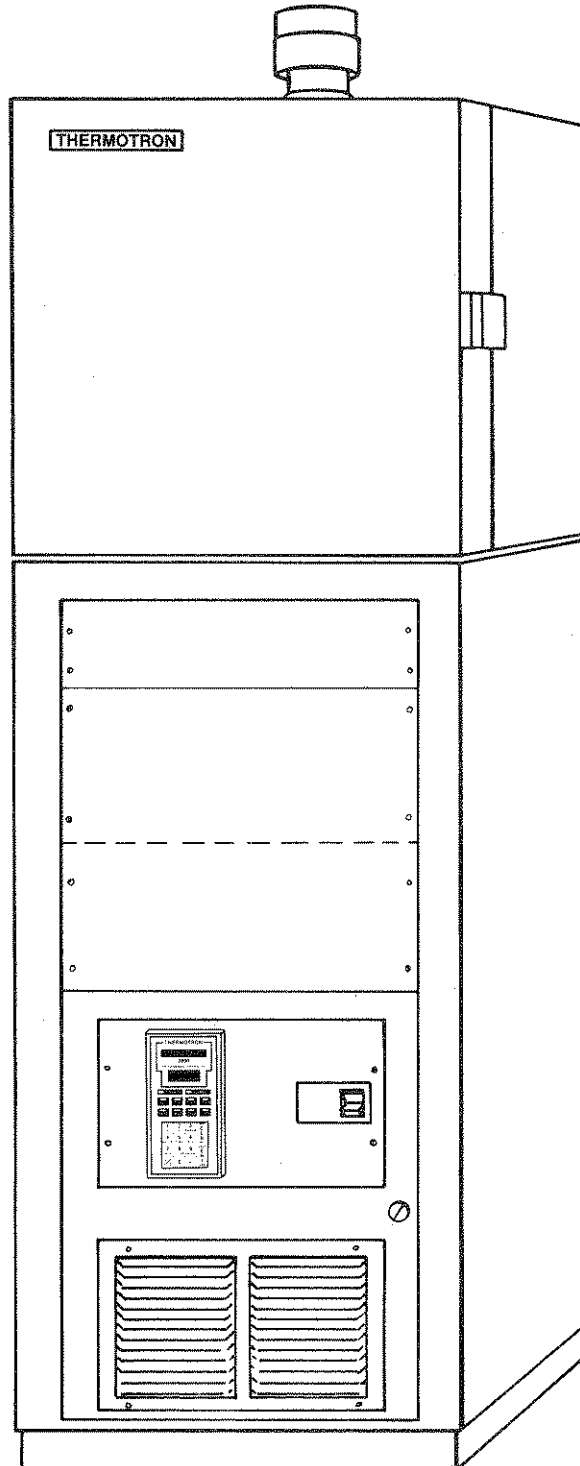

Model S1.2V is a vertical console chamber designed to test temperature tolerances. This chamber has an interior size of 1.2 cubic feet. Model S1.2V can be equipped with various options. See the Option Sheet in the front of the manual to know which options your chamber has.

TEMPERATURE CHAMBER MODEL S5.5C

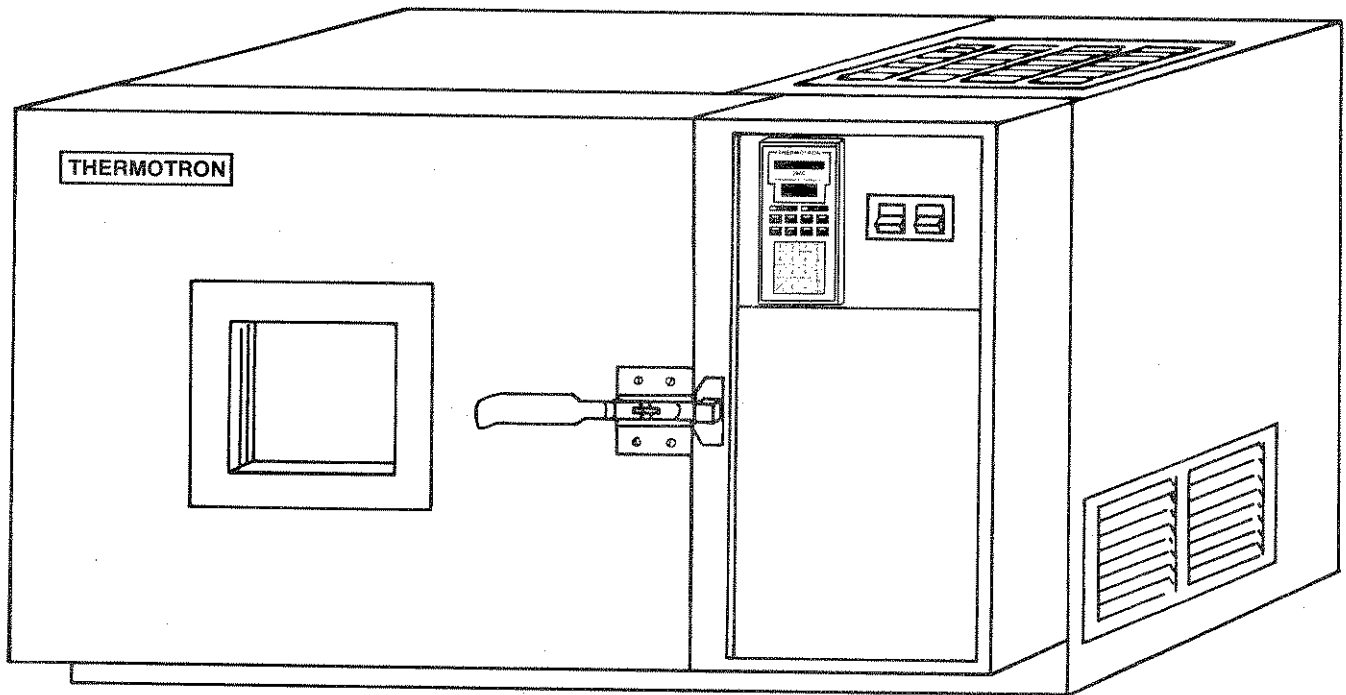

Model S5.5C is a bench top chamber designed to test temperature tolerances. This chamber has an interior size of 5.5 cubic feet. Model S5.5C uses a cascade refrigeration system for cooling. Model S5.5C can be equipped with various options. See the Option Sheet in the front of the manual to know which options your chamber has.



THE INSTALLATION

HOW TO INSTALL THE CHAMBER

CAUTION: Do not tip the chamber more than 45° when unpacking or moving.

WARNING: Always use an electrical supply system with separate electrical ground conductor and with a ground fault circuit interrupter. Consult an electrical contractor.

To prepare the chamber for use, follow this procedure:

1. Remove the chamber from the packing container.
2. Put the chamber on a solid, level surface in a well ventilated room.
3. Leave a minimum of 12 inches of air space on all sides of the chamber for air circulation. See Figure A1.

WARNING: Use of LN₂ or CO₂ in a chamber can result in a lack of oxygen in and around the chamber and can cause death.

4. If the chamber is equipped with either the LN₂ or the CO₂ boost injection system option, follow this procedure:
 - a. Connect a clean, dry supply of either LN₂ at 30 PSI or CO₂ at 1000 PSI maximum to the inlet side of the control solenoid valve. See Figure A2.
 - b. Connect a high pressure relief valve to the line to relieve pressure.
 - c. Insulate the line.
 - d. Vent the chamber to the outside of the building. Do **not** put the vent near the fresh air intake vents for the building.
5. Connect the power supply cord to the electrical service. See the specifications on Page 2, the serial number label on the chamber, and, if necessary, the electrical drawing(s) in the Parts List and Drawings section of the manual.

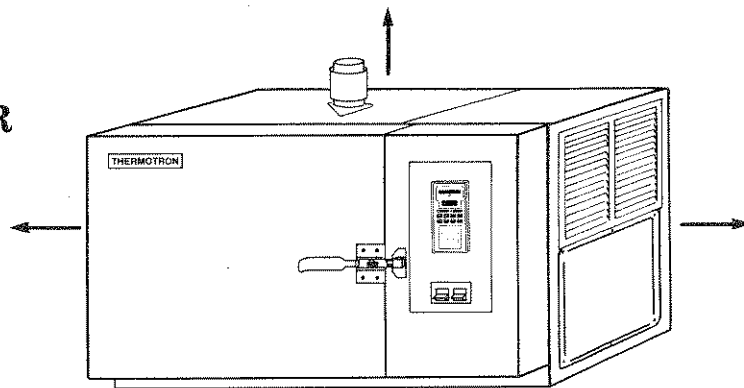

FIGURE A1

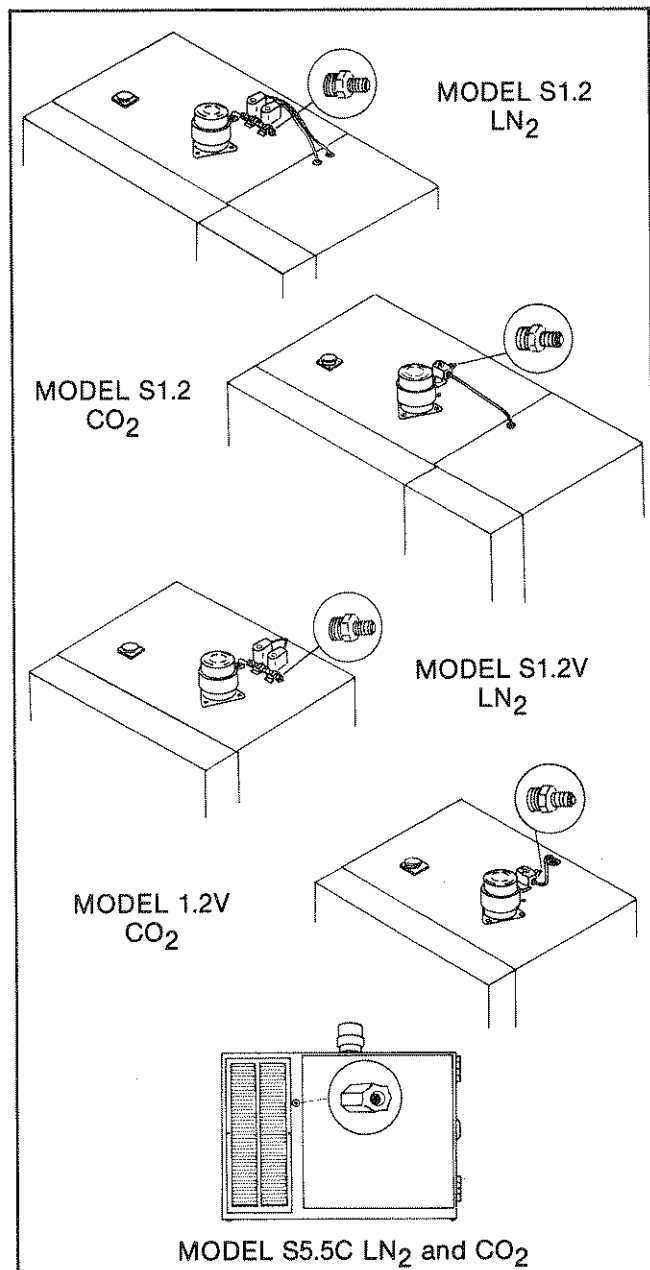

FIGURE A2

THE OPERATION

Models S1.2, S1.2V, and S5.5C chambers operate the same. Depending on options, your chamber can have additional or different controls. See the Option Sheet in the front of the manual to determine which options your chamber has. For additional operating information, see the Appendix section of this manual.

THE CONTROLS

The Control Panel

The control panel (1) is on the front side of the chamber. The control panel has the power switch (2) and the controls for the 2800 Programmer/Controller (3). It can also be equipped with an optional light switch (4). See Figure B1.

The Power Switch

The power switch (2) is on the control panel. In the ON position, the power switch allows the programmer/controller to begin operating the chamber.

The Light Switch (optional)

The light switch (4) operates a light in the chamber.

The Controls for the 2800 Programmer/Controller

For operating information on the 2800 Programmer/Controller (3), see the 2800 manual in the Appendix section.

The Controls for the Productsaver (optional)

If your chamber is equipped with a Productsaver, see the Productsaver manual in the Appendix section for more information.

The Controls for the Temperature Limit Detector, High Limit (optional)

If your chamber is equipped with a Temperature Limit Detector, High Limit, see the manual in the Appendix section for more information.

Continued on the next page.

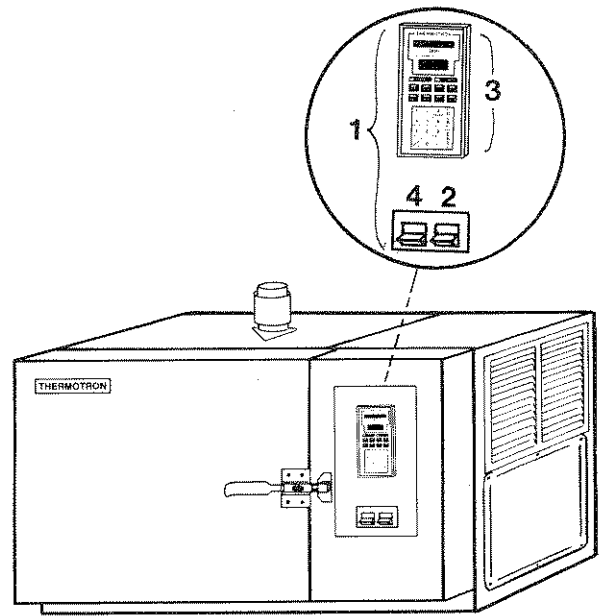

FIGURE B1

The LN₂ or CO₂ Boost Injection System (Optional)

If your chamber is equipped with either an LN₂ or a CO₂ boost injection system, the system is controlled by the 2800 Programmer/Controller. See "The Chamber Functions Controlled by the 2800" in the 2800 Programmer/Controller Manual in the Appendix section.

The Refrigeration Gauges (Optional)

The refrigeration gauges measure the pressure of the refrigerant in the refrigeration systems of the chamber.

The Controls for a Temperature Recorder (optional)

If your chamber is equipped with a temperature recorder, see the recorder manual in the Appendix for more information.

The Heat Links

The chamber is internally equipped with fusible heat links. If the temperature at the heater exceeds 460°F, the heat links remove power from the chamber heaters to protect the chamber. The heat links do **not** remove power from the product on test. See Figure B2.

The Controls for the Therm-Alarm (optional)

If your chamber is equipped with a Therm-Alarm, see the Therm-Alarm manual in the appendix section for more information.

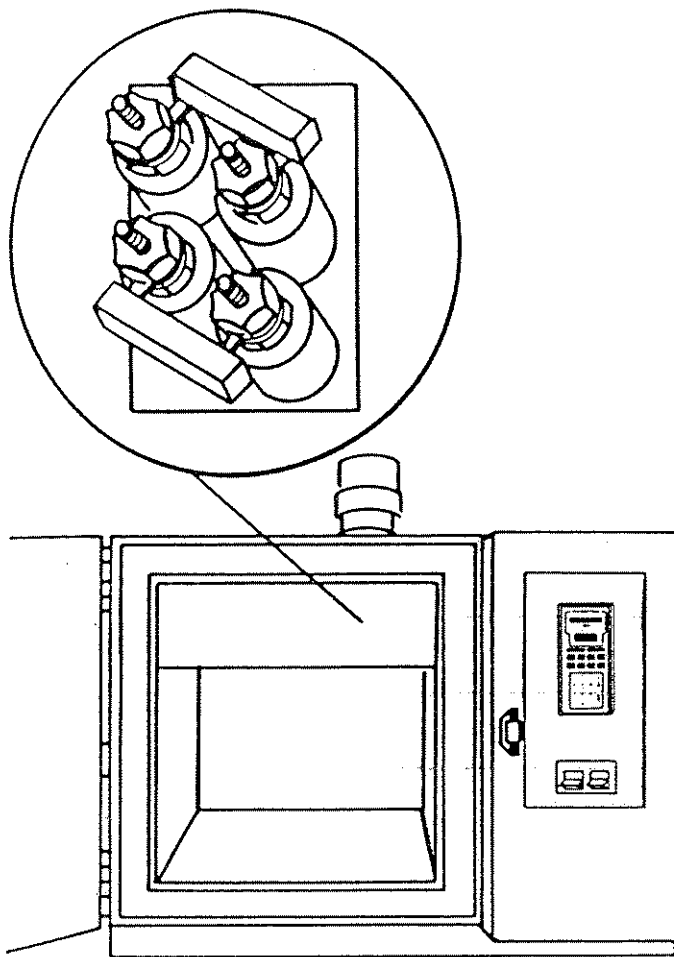



FIGURE B2

HOW TO OPERATE THE CHAMBER

 **WARNING:** Do not operate this chamber unless it is completely assembled.

 **WARNING:** This equipment operates at extreme high and low temperatures. Human exposure to temperatures other than 24°C (75°F) can cause injury.

To operate the chamber, follow this procedure:

1. Place the product to be tested inside the chamber. Make sure the door is securely closed.
2. Program the 2800 Programmer/Controller. See the Appendix section for the 2800 Programmer/Controller Operator Manual.
3. Turn the power switch to the **ON** position.

HOW TO REMOVE A PRODUCT FROM TEST

WARNING: If the chamber temperature exceeds the safe limits for the product on test, remove power from the chamber and from the product on test. A Productsaver, or an equivalent device, is necessary to remove power from the product on test.

To remove a product on test from the chamber, follow this procedure:

1. Change the temperature setpoint to 24°C (75°F), ambient temperature.
2. Allow the product to reach 24°C (75°F), ambient temperature, before removing the product from the chamber.

WARNING: Use of LN₂ or CO₂ in a chamber can result in a lack of oxygen in and around the chamber and can cause death.

3. If the chamber has LN₂ or CO₂, replace the atmosphere inside the chamber with room air. To replace the atmosphere, follow this procedure:
 - a. Turn the LN₂ or CO₂ off. For information on how to turn the LN₂ or CO₂ off, see the controller manual in the Appendix section.
 - b. Remove the port plug. See Figure B3.
 - c. Operate the chamber for 5 minutes. The chamber circulator fan will remove the LN₂ or CO₂ from the inside of the chamber.
 - d. Replace the port plug.
4. Turn the main power switch to the OFF position.
5. Open the door of the chamber. Remove the product from the chamber.

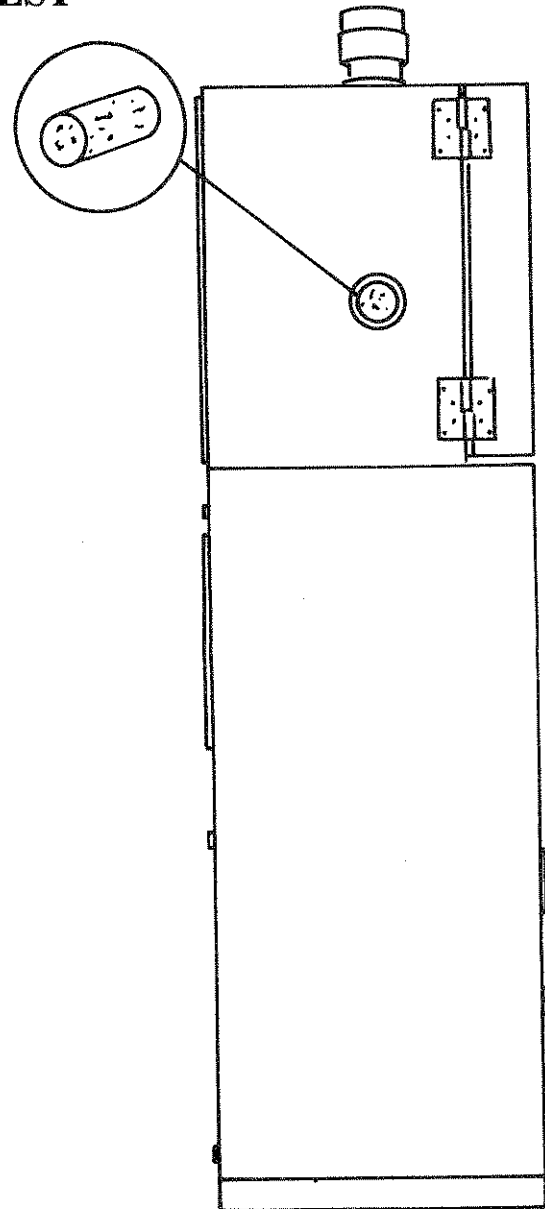

FIGURE B3

THE PREVENTIVE MAINTENANCE

⚠ WARNING: To prevent injury and damage, disconnect the electric power from the chamber before doing any maintenance or service to the chamber.

⚠ WARNING: When working with refrigerant, follow all the safety instructions on the container of refrigerant.

⚠ WARNING: Make sure all the labels, the warnings, and the cautions are fastened to the chamber. Order new labels from Thermotron Industries, Inc.

⚠ WARNING: Maintenance must be done by authorized personnel only.

HOW TO CLEAN THE CONDENSER FIN COILS ON MODEL S1.2

The condenser fin coils need to be cleaned every six months. If the chamber is in a dusty or dirty environment, clean the condenser fin coils more often.

To clean the condenser fin coils, follow this procedure:

1. Disconnect the main power from the chamber.
2. Remove the two screws (1) that hold the louvered panel (2) to the back of the chamber. See Figure C1.
3. Remove the louvered panel.
4. Remove the eight screws (3) that hold the side panel (4) to the right side of the chamber.
5. Remove the side panel.
6. Use an OSHA approved source of compressed air to blow all the dust and dirt from the condenser fin coil (5).
7. Install the side panel.
8. Install the louvered panel.

If further maintenance is required, contact your local Thermotron field service office.

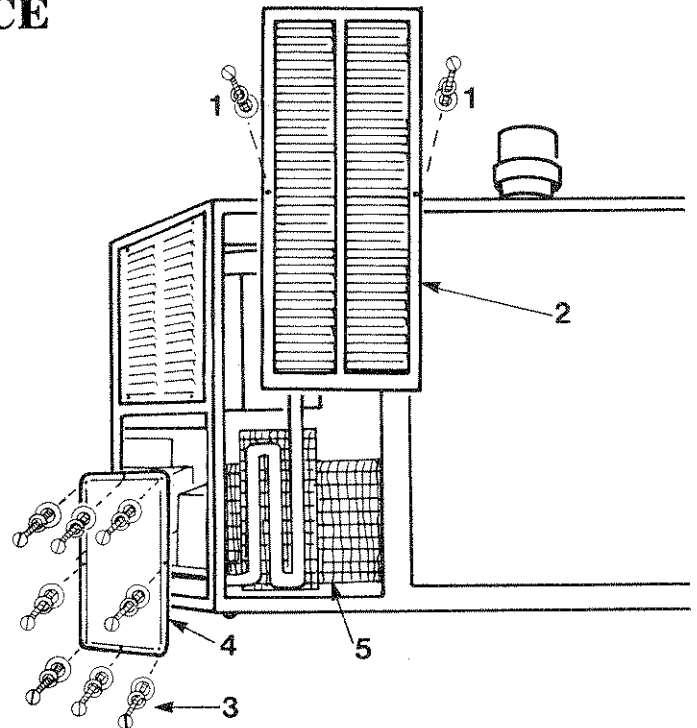

FIGURE C1

HOW TO CLEAN THE CONDENSER FIN COILS ON MODEL S1.2V

The condenser fin coils need to be cleaned every six months. If the chamber is in a dusty or dirty environment, clean the condenser fin coils more often.

To clean the condenser fin coils on Model S1.2V, follow this procedure:

1. Disconnect the power from the chamber.
2. To open the door at the rear of the console follow this procedure:
 - a. Loosen the latch screws (1) on the door (2). Do not remove the screws from the door. See Figure C2.
 - b. Turn the key (3) to the left.
 - c. Open the door.
3. To open the front door (1) of the console, turn the key (2) to the left. See Figure C3.
4. Use an OSHA approved source of compressed air to blow all the dust and dirt from the condenser fin coil (3).
5. Close and lock the front door of the console.
6. Close and lock the rear door of the console.

If further maintenance is required, contact your local Thermotron field service office.

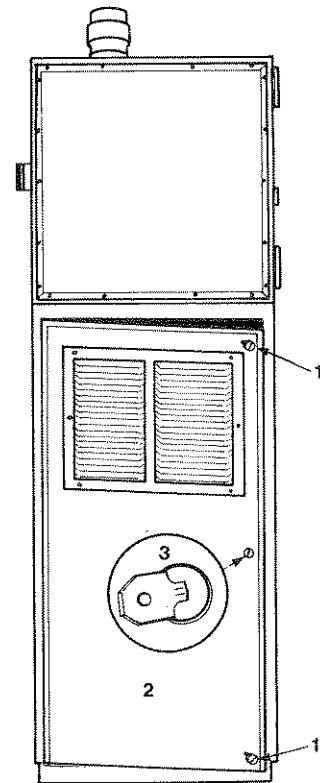

FIGURE C2

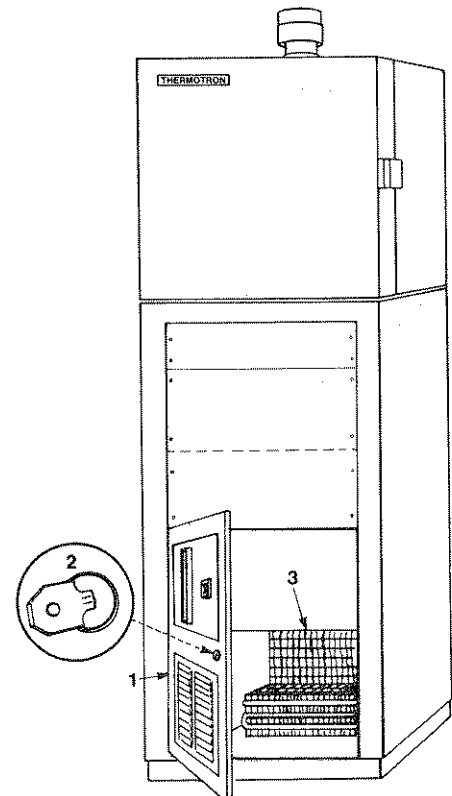

FIGURE C3

HOW TO CLEAN THE CONDENSER FIN COILS ON MODEL S5.5C

The condenser fin coils need to be cleaned every six months. If the chamber is in a dusty or dirty environment, clean the condenser fin coils more often.

To clean the condenser fin coils on Model S5.5C, follow this procedure:

1. Disconnect the main power from the chamber.
2. Remove the four screws (1) that hold the louvered panel (2) to the top of the chamber. See Figure C4.
3. Remove the louvered panel.
4. From the inside of the chamber, blow all the dust and dirt from the condenser fin coil (3). Use an OSHA approved source of compressed air. Do not remove the condenser fan guard (4).
5. Install the louvered panel.

If further maintenance is required, contact your local Thermotron field service office.

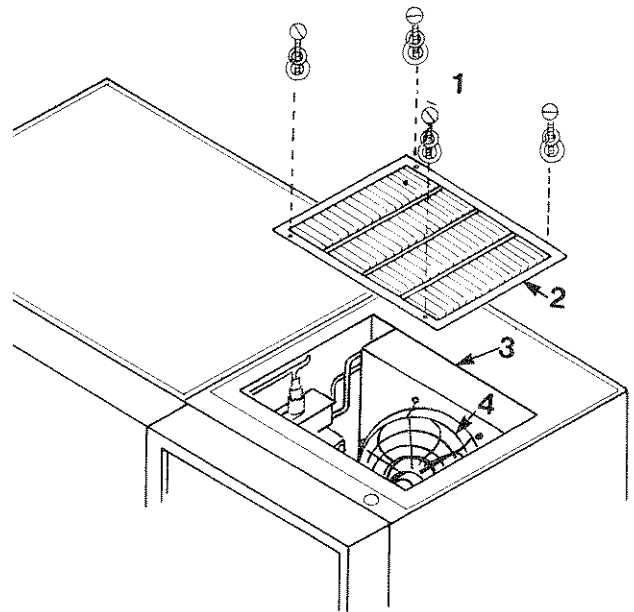

FIGURE C4

HOW TO CHECK THE PRESSURE OF THE REFRIGERATION SYSTEM ON MODEL S1.2

The refrigeration charge on Model S1.2 is very critical. The refrigeration system is not designed to be field serviceable. If your Model S1.2 is not properly cooling, follow this procedure:

1. Clean the condenser fin coils. See Page C1, **How to Clean the Condenser Fin Coils on Model S1.2**
2. If the condenser fin coils are clean and the chamber does not cool, contact your local Thermotron field service office.

HOW TO CHECK THE R-13 STANDBY PRESSURE ON MODEL S1.2V

The refrigeration charge on Model S1.2V is critical. If the chamber is not equipped with refrigeration gauges, it is not designed to be field serviceable.

If your Model S1.2V is not equipped with refrigeration gauges and is not properly cooling, follow this procedure:

1. Clean the condenser fin coils. See Page C2, **How to Clean the Condenser Fin Coils on Model S1.2V.**
2. If the chamber fin coils are clean and the chamber does not cool, contact your local Thermotron field service office.

HOW TO CHECK THE R-13 STANDBY PRESSURE ON MODEL S1.2V AND MODEL S5.5C EQUIPPED WITH REFRIGERATION GAUGES

If Model S1.2V and Model S5.5C are equipped with refrigeration gauges, check the standby pressure of the R-13 system once every three months.

To determine the standby pressure of the R-13 refrigeration system in a chamber, follow this procedure:

1. Make sure the entire R-13 refrigeration system is near $+24^{\circ}\text{C}$ ($+75^{\circ}\text{F}$), ambient temperature.
 - a. If the chamber has been in use, it will take four to eight hours for the R-13 refrigeration system to reach ambient temperature.
2. Make sure the system is equalized.
 - a. The R-13 refrigeration gauges (1 and 2) must have equal readings. See Figure C5.
3. Read the standby pressure on the R-13 discharge gauge (1).
 - a. This pressure must be the same as the pressure indicated on the equipment serial number label.
 - b. On Model S1.2V if the pressure is not the same, contact your local Thermotron field service office.
 - c. On Model S5.5C, if the pressure is not the same, see Page D4, **How to Charge the R-13 Refrigeration System on Model S5.5C**

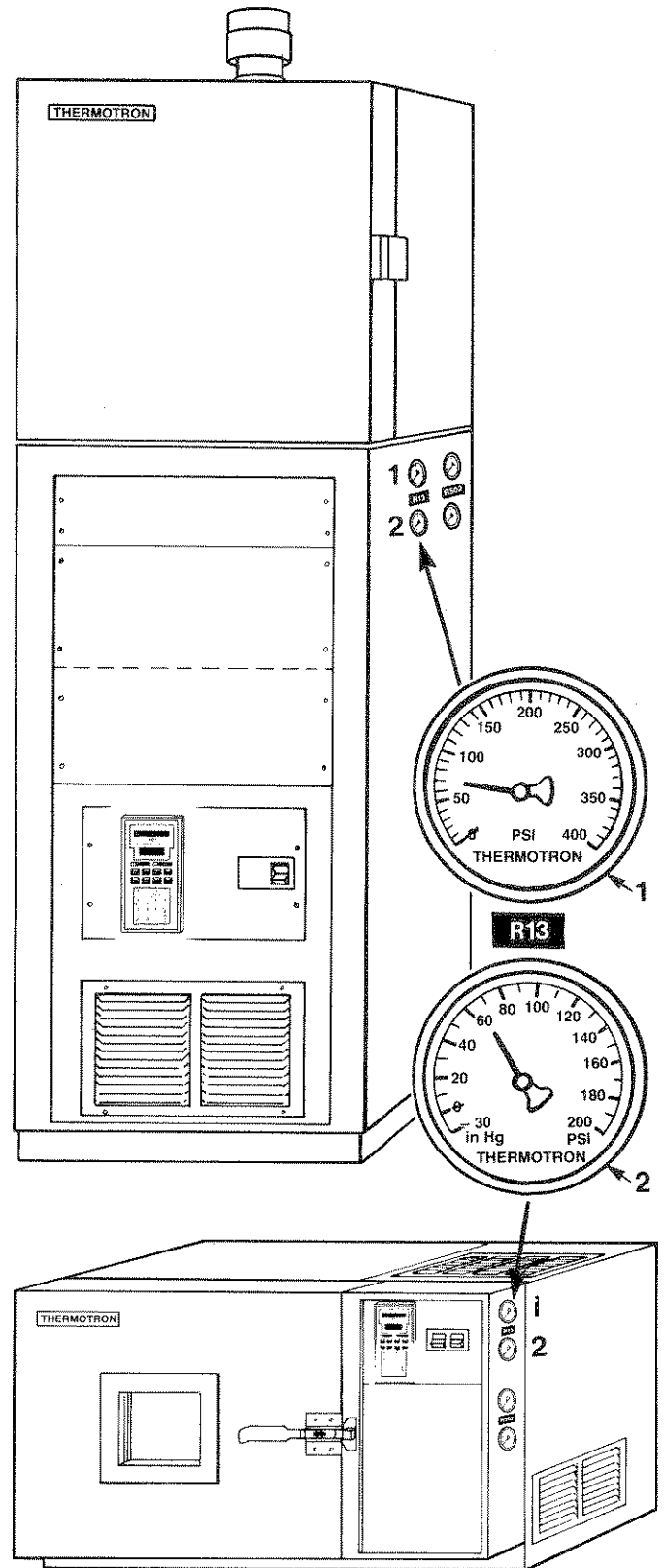

FIGURE C5

HOW TO CHECK THE REFRIGERATION SYSTEM ON MODEL S5.5C NOT EQUIPPED WITH REFRIGERATION GAUGES

If your Model S5.5C is not equipped with refrigeration gauges and is not properly cooling, follow this procedure:

1. Clean the condenser fin coils. See Page C3, **How to Clean the Condenser Fin Coils on Model S5.5C.**
2. If the condenser fin coils are clean and the chamber does not cool, check the charge of the R-502 refrigeration system. See Page C7, **How to Check the Charge of the R-502 Refrigeration System on Model S5.5C.**
3. If the charge of the R-502 refrigeration is good and the chamber does not cool, check the standby pressure of the R-13 refrigeration system. See Pages C8 and C9, **How to Check the R-13 Standby Pressure on Model S5.5C Using a Refrigeration Gauge Manifold.**

HOW TO CHECK THE CHARGE OF THE R-502 REFRIGERATION SYSTEM ON MODEL S5.5C

To check the charge of the R-502 refrigeration system on Model S5.5C, follow this procedure:

1. Remove the 16 screws (1) from the left rear panel (2) of the chamber. See Figure C6.
2. Remove the cap (3) from the sightglass (4).
3. To start the refrigeration system, select a setpoint requiring full cool. If necessary, see the controller manual in the Appendix section.
4. Operate the chamber for two minutes.
5. Visually check the sightglass for bubbles.
 - a. If the sightglass has bubbles in it, the R-502 refrigeration system needs refrigerant added. See Page D6, **How to Charge the R-502 Refrigeration System on Model S5.5C**.
 - b. If the sightglass does not have bubbles in it, the R-502 system has sufficient refrigerant. Check the R-13 standby pressure.

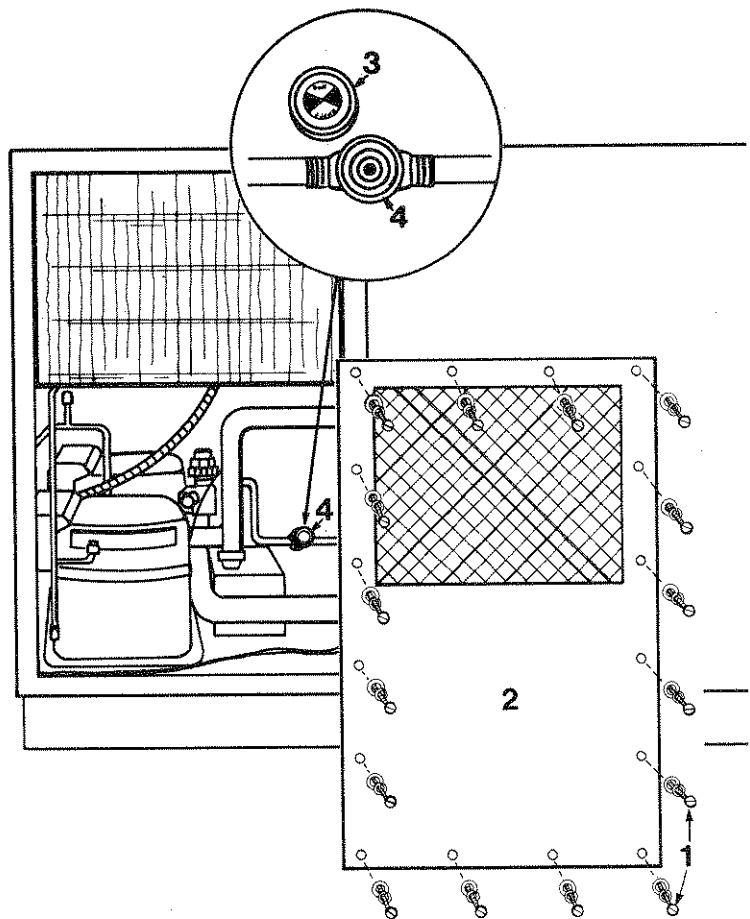

FIGURE C6

HOW TO CHECK THE R-13 STANDBY PRESSURE ON MODEL S5.5C USING A REFRIGERATION GAUGE MANIFOLD

To use a refrigeration gauge manifold to check the standby pressure of the R-13 refrigeration system on Model S5.5C, follow this procedure:

1. Make sure the entire R-13 refrigeration system is near $+24^{\circ}\text{C}$ ($+75^{\circ}\text{F}$), ambient temperature.
 - a. If the chamber has been in use, it will take four to eight hours for the R-13 refrigeration system to reach ambient temperature.
2. Remove the 16 screws (1) from the left rear panel (2) of the chamber. See Figure C6 on Page C7.
3. Remove the cap from the discharge valve (6) of the R-13 compressor (8). See Figure C7.
4. Close the two valves (1 and 2) on the refrigeration gauge manifold (3). See Figure C7.
5. Tightly connect the discharge gauge hose (4) to the refrigeration gauge manifold and to the discharge valve (6). See Figure C7.
6. Turn the suction service valve (7) on the compressor all the way counterclockwise (backseated).
7. Tightly connect the suction gauge hose (5) to the refrigeration gauge manifold and to the suction service valve (7).
8. Open the suction service valve 1/2 turn clockwise.
9. The two manifold gauges must have equal readings.

Continued on the next page.

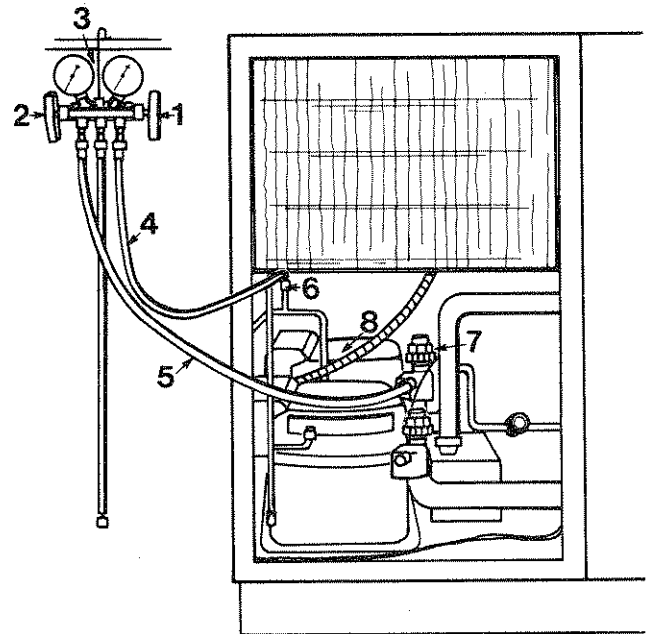

FIGURE C7

10. Read the pressure measured on the discharge gauge.
 - a. If the pressure measured on the discharge gauge is the same as the pressure recorded on the serial number label and your chamber is not properly cooling, contact your local Thermotron field service office.
 - b. If the pressure measured on the discharge gauge differs by approximately 10 or more P.S.I.G. from the serial number label, the system must be charged. See Page D4, **How to Charge the R-13 Refrigeration System on Model S5.5C.**

THE SERVICE

- ⚠ WARNING:** To prevent injury and damage, disconnect the electric power from the chamber before doing any maintenance or service to the chamber.
- ⚠ WARNING:** When working with refrigerant, follow all the safety instructions on the container of refrigerant.
- ⚠ WARNING:** Make sure all the labels, the warnings, and the cautions are fastened to the chamber. Order new labels from Thermotron Industries, Inc.
- ⚠ WARNING:** Service must be done by authorized personnel.

HOW TO REPLACE THE HEAT LINKS ON MODELS S1.2 AND S1.2V

Models S1.2 and S1.2V are each equipped with one or more heat links that turn the power to the chamber heaters off when the temperature exceeds 460°F. This protects the chamber.

If a heat link has blown, the chamber will not heat.

To replace the heat link on Models S1.2 and S1.2V, follow this procedure:

1. Disconnect the main power from the chamber.
2. Open the chamber door.
3. Remove the two screws (1) that hold the front baffle (2) to the chamber. See Figure D1.
4. Remove the front baffle.
5. Remove the four screws (3) that hold the bottom baffle (4) to the chamber.
6. Remove the bottom baffle.
7. Remove the two screws (1) that hold the heater frame (2) to the chamber. See Figure D2.

Continued on the next page.

THERMOTRON

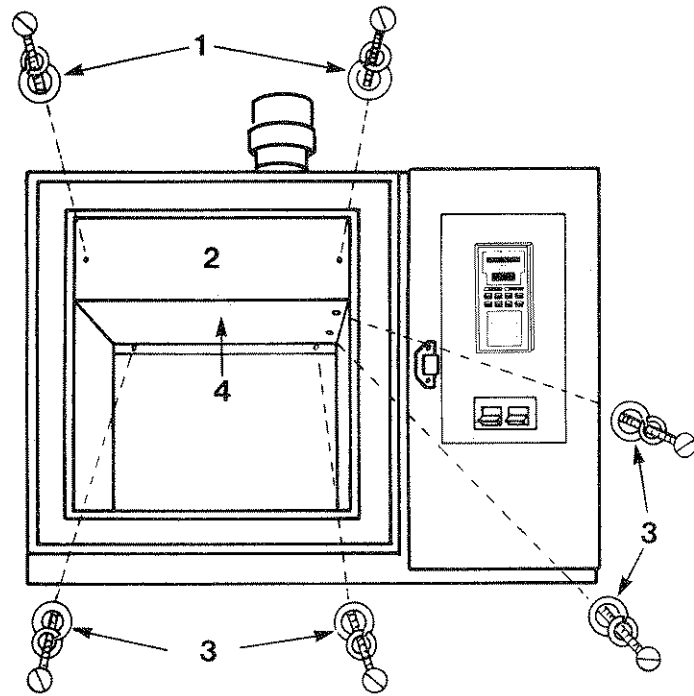

FIGURE D1

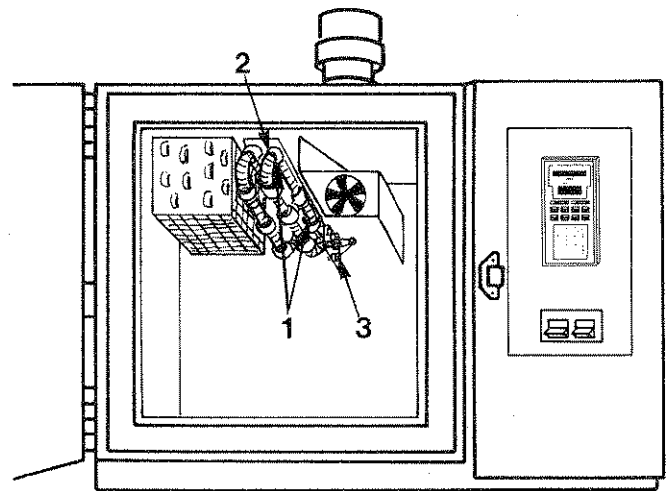

FIGURE D2

8. Lower the heater frame.
9. The heat link (3) is mounted on the back of the heater frame. If necessary, see the electrical drawing in the Parts List and Drawings section of the manual. The heat links are labeled HL on the electrical drawing.
10. Visually check the heat link. If the heat link has blown, replace the heat link. See Figure D3.
11. Loosen the two nuts (1) that hold the heat link on the insulated studs.
12. Remove the heat link.
13. Insert a new heat link.
14. Tighten the two nuts.
15. Install the heater frame.
16. Install the bottom baffle.
17. Install the front baffle.
18. Connect the main power to the chamber.
19. Check the amperage on the heaters.

If further service is required, contact your local Thermotron field service office.

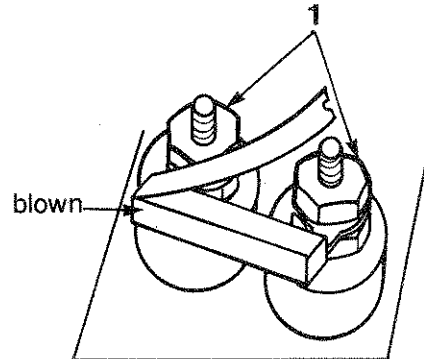
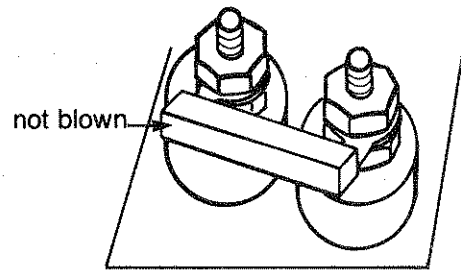

FIGURE D3

HOW TO REPLACE THE HEAT LINKS ON MODEL S5.5C

Model S5.5C is equipped with one or more heat links that turn the power to the chamber heaters off when the temperature exceeds 460°F. This protects the chamber.

If a heat link has blown, the chamber will not heat.

To replace the heat links on Model S5.5C, follow this procedure:

1. Disconnect the main power from the chamber.
2. Open the chamber door.
3. Remove the eight screws that hold the baffle (1) to the chamber. See Figure D4.
4. Remove the baffle.
5. The heat links (1) are mounted behind the heater (2). See Figure D5. If necessary, see the electrical drawing in the Parts List and Drawings section of the manual. The heat links are labeled HL on the electrical drawing.
6. Visually check the heat links. If one or both of the heat links have blown, both of the heat links must be replaced. See Figure D6.
7. Loosen the two nuts (1) that hold a heat link. Remove the heat link.
8. Insert a new heat link. Tighten the two nuts.
9. Replace the second heat link.
10. Install the baffle.
11. Connect the main power to the chamber.
12. Check the amperage on the heaters.

If further service is required, contact your local Thermotron field service office.

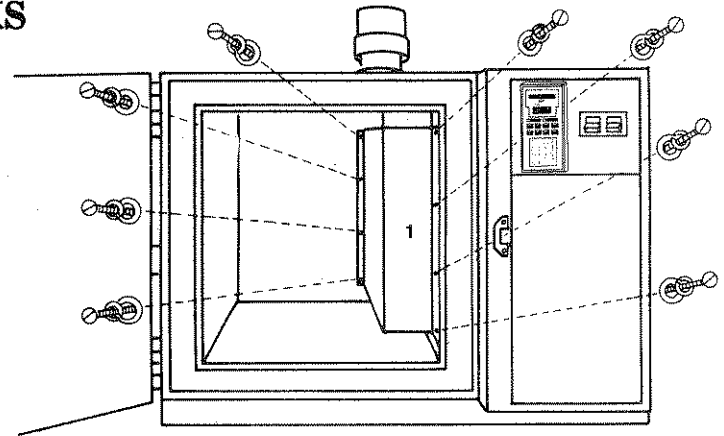

FIGURE D4

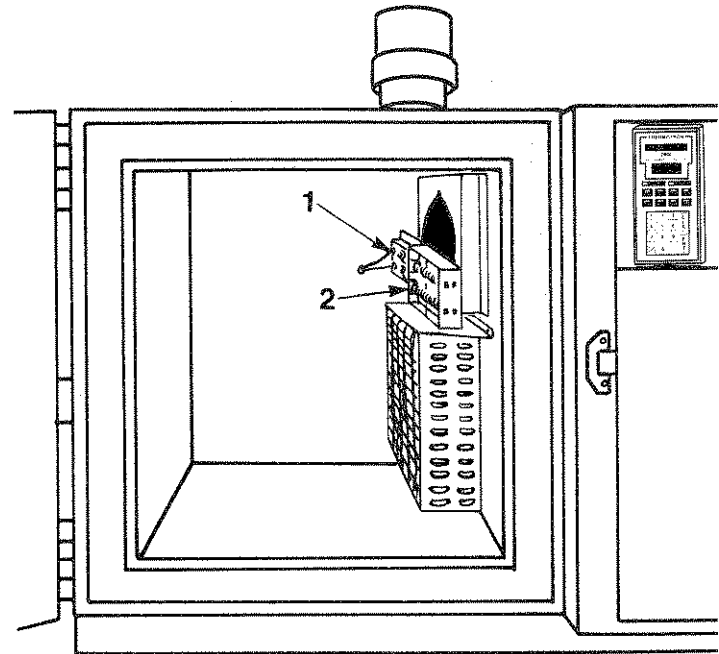

FIGURE D5

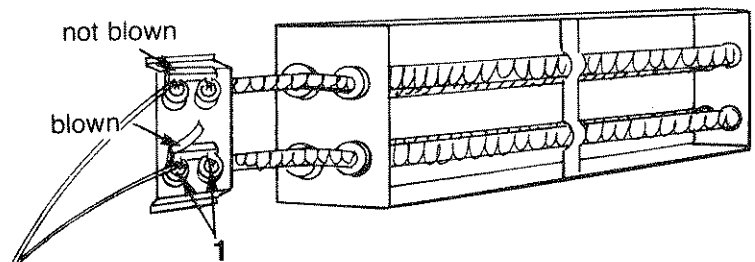

FIGURE D6

HOW TO CHARGE THE R-13 REFRIGERATION SYSTEM ON MODEL S5.5C

⚠ WARNING: Follow all the safety instructions on the container of refrigerant 13.

To add refrigerant to the R-13 system, follow this procedure:

1. Have a supply of refrigerant 13 before beginning to charge the R-13 refrigeration system.
2. Turn the two valves (1 and 2) on the refrigeration gauge manifold (3) clockwise to close the valves. See Figure D7.
3. Connect the three charging hoses (4, 5, and 6) to the refrigeration gauge manifold as shown in Figure D7.
4. Make sure the outlet valve (7) on the tank of refrigerant 13 is in the **OFF** position.
5. Connect the center charging hose (5) to the outlet valve on the tank of refrigerant 13.
6. Connect the discharge gauge hose (6) to the discharge valve (8) on the compressor for the R-13 refrigeration system.
7. Turn the suction service valve (9) on the compressor all the way counterclockwise (backseated).
8. Connect the suction gauge hose (4) to the suction service valve. Do not tighten the hose connection.
9. To purge (bleed) a small amount of refrigerant through the charging hose, follow this procedure:
 - a. Open the suction gauge valve on the refrigeration gauge manifold.
 - b. Slightly open the outlet valve on the tank of refrigerant 13.

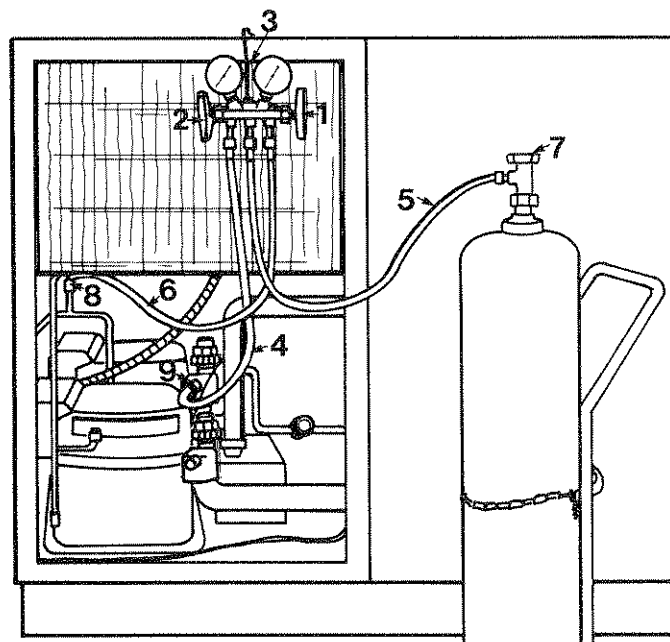

FIGURE D7

Continued on the next page.

10. Close the outlet valve on the tank of refrigerant 13.
11. Tighten the charging hose connection.
12. Turn the suction service valve (9) on the compressor 1/2 turn clockwise.
13. To add refrigerant 13, follow this procedure:
 - a. Slowly open the outlet valve on the tank of refrigerant 13.
 - b. Observe the suction gauge.
 - c. When the pressure in the gauge matches the pressure on the serial number label, close the outlet valve on the tank of refrigerant 13.
14. Wait for the pressure on the gauges to equalize. Compare the pressure on the gauges with the pressure recorded on the serial number label.
 - a. If the pressure on the gauge matches the pressure on the serial number label, go to Step 15.
 - b. If the pressure on the gauge does not match the pressure on the serial number label, repeat Steps 13 and 14.
15. Turn the suction gauge valve on the refrigeration gauge manifold completely clockwise.
16. To remove the refrigeration gauge manifold, follow this procedure.
 - a. Turn the suction service valve completely counterclockwise.
 - b. Remove the suction gauge hose.
 - c. Remove the discharge gauge hose from the discharge valve.

HOW TO CHARGE THE R-502 REFRIGERATION SYSTEM ON MODEL S5.5C

⚠ WARNING: Follow all the safety instructions on the container of refrigerant 502.

To charge the R-502 system, follow this procedure:

1. Have a supply of refrigerant 502 before beginning to charge the R-502 refrigeration system.
2. Turn the two valves (1 and 2) on the refrigeration gauge manifold (3) clockwise to close the valves. See Figure D8.
3. Connect the two charging hoses (4 and 5) to the refrigeration gauge manifold as shown in Figure D8.
4. Make sure the outlet valve (6) on the tank of refrigerant 502 is in the **OFF** position.
5. Connect the center charging hose (4) to the outlet valve on the tank of refrigerant 502
6. Turn the suction service valve (7) on the R-502 compressor (8) all the way counterclockwise (backseated).
7. Connect the suction gauge hose (5) to the suction service valve. Do not tighten the hose connection.
8. To purge (bleed) a small amount of refrigerant through the charging hose, follow this procedure:
 - a. Turn the suction gauge valve on the refrigeration gauge manifold to open the valve.
 - b. Slightly open the outlet valve on the tank of refrigerant 502.
9. Close the outlet valve on the tank of refrigerant 502.

Continued on the next page.

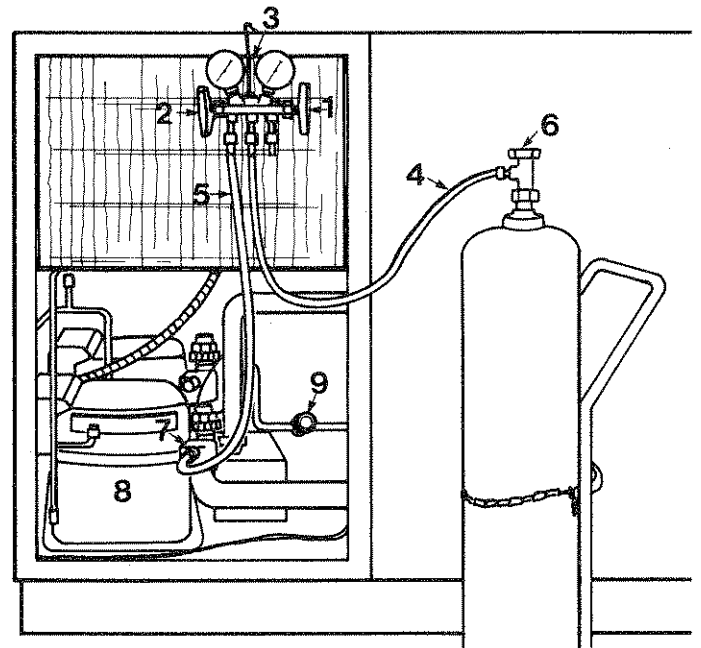

FIGURE D8

10. Tighten the charging hose connection.
11. Turn the suction service valve (7) on the compressor 1/2 turn clockwise.
12. To start the refrigeration system, select a setpoint requiring maximum cooling. If necessary, see the controller manual in the Appendix section.
13. Operate the chamber for five minutes.
14. Visually check the sightglass (9) for bubbles.
15. If the sightglass has bubbles in it, open the outlet valve on the tank of refrigerant 502. Allow refrigerant to flow until there are no more bubbles in the sightglass.
16. Close the outlet valve on the refrigerant 502 tank.
17. Watch the sightglass while the chamber continues to operate at maximum cool.
 - a. If bubbles appear in the sightglass, repeat steps 15 and 16.
 - b. If bubbles do not appear in the sightglass, go to Step 18.
18. Turn the suction service valve full counterclockwise.
19. Remove the suction gauge hose.

RECOMMENDED SPARE PARTS

To minimize down time, maintain a supply of spare parts. See the parts list in this section to determine parts and Thermotron part (item) numbers.

HIGH USAGE PARTS

- Contactors
- Filter Driers
- Fuses
- Heat Links
- Solenoids

LOW USAGE PARTS WITH LONG LEAD TIMES

- Circulator Motors
- Compressors

OTHER RECOMMENDED PARTS

- Bulbs, Lights, Lamps
- Demineralizer Cartridges
- Expansion Valves
- Injection Valves
- Fan Blades
- Heating Coils
- Limit Switches
- Pressure Switches
- Push Button Switches
- Selector Switches
- Toggle Switches
- Relays
- Sensors
- Thermocouples
- Thermostats

HOW TO RETURN MATERIALS

WHAT TO DO IF A PART FAILS

If a part fails, follow this procedure:

1. Contact your local Thermotron field service office. The field service office will exchange or replace the part whenever possible.
2. If your local field service office does not have the necessary part, contact the Parts and Logistics Department at Thermotron Industries in Holland, Michigan.

Telephone: (616) 392-1498--7:30 AM to 5:00 PM Eastern Standard Time (EST)

3. If you must return a part to Thermotron Industries in Holland, Michigan for repair or replacement under the terms of the warranty, follow this procedure:

- a. Telephone the Thermotron Parts and Logistics Department at (616) 392-1498 between 7:30 AM and 5:00 PM EST. Parts and Logistics will authorize the return of the material and issue you a returned material tag (RMT) number.
- b. Write the RMT number on the outside of the carton in an obvious place.
- c. Write the RMT number on the packing list. Write also the name and telephone number of a contact person on the packing list.

NOTE: Steps 3b and 3c are necessary for the proper handling of returned materials.

- d. To order a replacement part, Thermotron requires the following information:
 - the complete, six-digit Thermotron part number (See the parts list in this section.)
 - the serial number of the chamber that requires the replacement part (See the Option Sheet in the front of this manual or the serial number tag on the chamber.)
 - the specific problem with the failed part
 - a purchase order number

NOTE: Thermotron will replace a part under the terms of the warranty at no charge if Thermotron receives the defective part within 30 days of the day that the RMT number was issued. If Thermotron does not receive the defective part within 30 days, Thermotron will invoice you for the full cost of the replacement part.

- e. Ship all parts freight on board (FOB) Holland, Michigan 49423.

WHAT TO DO IF A THERMOTRON INSTRUMENT FAILS

If an instrument made by Thermotron fails, follow this procedure:

1. Contact your local Thermotron field service office. The field service office will exchange, replace or repair the Thermotron instrument whenever possible.
2. If your local field service office cannot exchange, replace or repair the Thermotron instrument, contact the Parts and Logistics Department at Thermotron Industries in Holland, Michigan.

Telephone: (616) 392-1498--7:30 AM to 5:00 PM Eastern Standard Time (EST)

3. If you must return a Thermotron instrument to Thermotron Industries in Holland, Michigan for repair or replacement under the terms of the warranty, follow this procedure:
 - a. Telephone the Thermotron Parts and Logistics Department at (616) 392-1498 between 7:30 AM and 5:00 PM EST. Parts and Logistics will authorize the return of the material and issue a returned material tag (RMT) number.
 - b. Write the RMT number on the outside of the carton in an obvious place.
 - c. Write the RMT number on the packing list. Write also the name and phone number of a contact person on the packing list.

NOTE: Steps 3b and 3c are necessary for the proper handling of returned materials.

- d. Fill out **both** sides of a blue RITE tag and attach it to the Thermotron instrument. Make sure to write the RMT number on the RITE tag. (Two RITE tags are in the front pocket of this manual.)

NOTE: Thermotron will replace a Thermotron instrument under the terms of the warranty at no charge if Thermotron receives the defective instrument within 30 days of the day that the RMT number was issued. If Thermotron does not receive the defective instrument within these 30 days, Thermotron will invoice you for the full cost of the replacement instrument.

- e. Ship the instrument(s) freight on board (FOB) Holland, Michigan 49423.

WHAT TO DO IF A NON-THERMOTRON INSTRUMENT FAILS

If an instrument that is NOT made by Thermotron fails, follow this procedure:

1. Contact your local Thermotron field service office. The field service office will exchange, replace or repair the instrument whenever possible.
2. If your local field service office cannot exchange, replace or repair the instrument, see the manual for the instrument in the Appendix section for warranty information.
3. If you need further assistance, contact the Parts and Logistics Department at Thermotron Industries in Holland, Michigan.

Telephone: (616) 392-1498--7:30 AM to 5:00 PM Eastern Standard Time

HERMOTRON INDUSTRIES

JOB _____ MODEL S 1.2 C VOLTAGE _____ SHEET 1 OF 1

OPERATION ELECTRICAL ASSEMBLY CHAMBER B/M REFERENCE 722413/722421

SYMBOL	DESCRIPTION	THERM NO	QTY
SUPP	SUPPRESSOR CAPACITOR .22MFD 400VT	720372	1
CIRC	MOTOR CIRC. 1/15 HP 3000RPM	569175	1
HEATER	HEATER CHAMBER 500W 115VT	541424	1
HL	THERMOSTAT HEAT LIMITER 460°F	534010	1
T/C	THERMOCOUPLE TYPE "T" 20 ga.	151008	1
SWI	SWITCH ROCKER SPST	720313	1
PLATE	PLATE SWITCH POWER	720925	1
C/D HEAD	CONTROL/DISPLAY HEAD 2800	705985	1
CABLE	CABLE ASSY 2800 1"	718270	1
CONT.	CONTROLLER BOARD 2. CHA	705977	1
SSR1-3	RELAY SOLID STATE 10A	569450	3
C	CONTACTOR 2P 20A	570831	1
C-AUX	CONTACTOR AUX CONTACT	570882	1
CORD	POWER CORD	534584	1
BUSHING	BUSHING POWER CORD	562294	1
SEAL	SEAL VAPOR FAN MOTOR SHAFT PART A	552302	1
SEAL	SEAL VAPOR FAN MOTOR SHAFT PART B	552299	1
TB	TERMINAL BLOCK	553120	1
FILTER	FILTER LINE EMI	669024	1

JOB _____ MODEL S-1.2 VOLTAGE 115/1/60 SHEET / OF

REFRIGERATION PARTS LIST B/M 5246-13-7(Z)

ITEM	SYMBOL	DESCRIPTION	THERM NO	QTY
R01		COMPRESSOR R-13	543419	1
R02		CONDENSING UNIT R-12	543400	1
R03		ACCESS VALVE	561816	4
R04		RELIEF VALVE	545373	1
R05		VAPOR TANK	624837	1
R06	PS12	PRESSURE SWITCH 10-23-PSI	559331	1
R07	PS13	PRESSURE SWITCH 260-240-PSI	559323	1
R08		FILTER-DRIER R-12	562774	1
R09		FILTER-DRIER R-13	562774	1
R10		CASCADE CONDENSER	624829	1
R11		R-13 DESUPERHEATER	557355	1
R12		R-13 CAP TUBE	577755	8'
R13		R-12 CAP TUBE	577755	4.5'
R14		BLEED TUBING	577755	2'
R15		UNLOADER SOLENOID	549344	1
R16		FIN COIL	557428	1
R17		CAP TUBE	577801	2'
		REFRIGERATION SCHEMATIC	DWG	

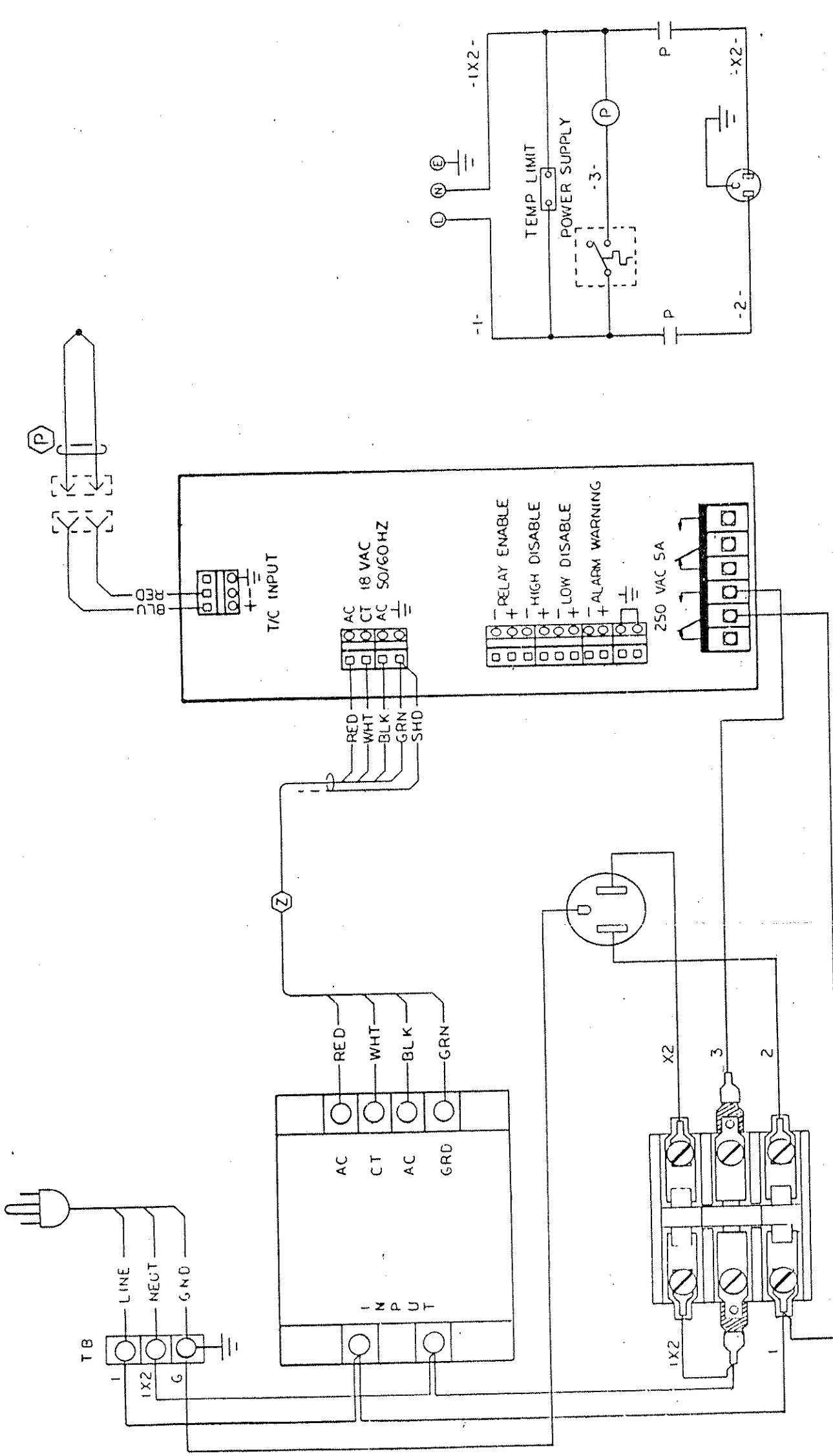

NO.		CHANGES	DATE	BY	CHK'D	NO.	CHANGES	DATE	BY	CHK'D	TOLERANCE	DESCRIPTION		SCALE	MATERIAL	FRUSH	DATE	BY	CHK'D	NO.	DATE	BY	CHK'D	NO.	SIZE		
												THERM-ALARM WIRING		S-1,2				DATE 1-7-67	K.F.D.			DATE 1-9-67	V.P.			E 15062	X

THERMOTRON

The system designs on this grid incorporate proprietary designs and CONFIDENTIAL TRADE SECRETS OF THERMOTRON INDUSTRIES. Access to this information is RESTRICTED. DO NOT use, disclose, publish or copy this information without express authorization.

THERMOTRON INDUSTRIES, INC., BOLLINGER, MISSOURI 63018 U.S.A.

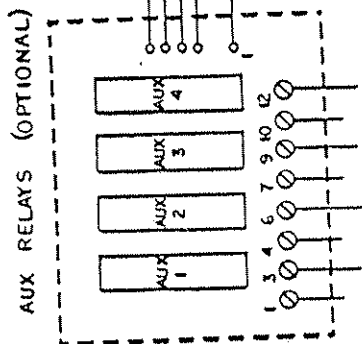

● USE WIRE NUM. 5 FOR CO2
USE WIRE NUM. A2 FOR LN2

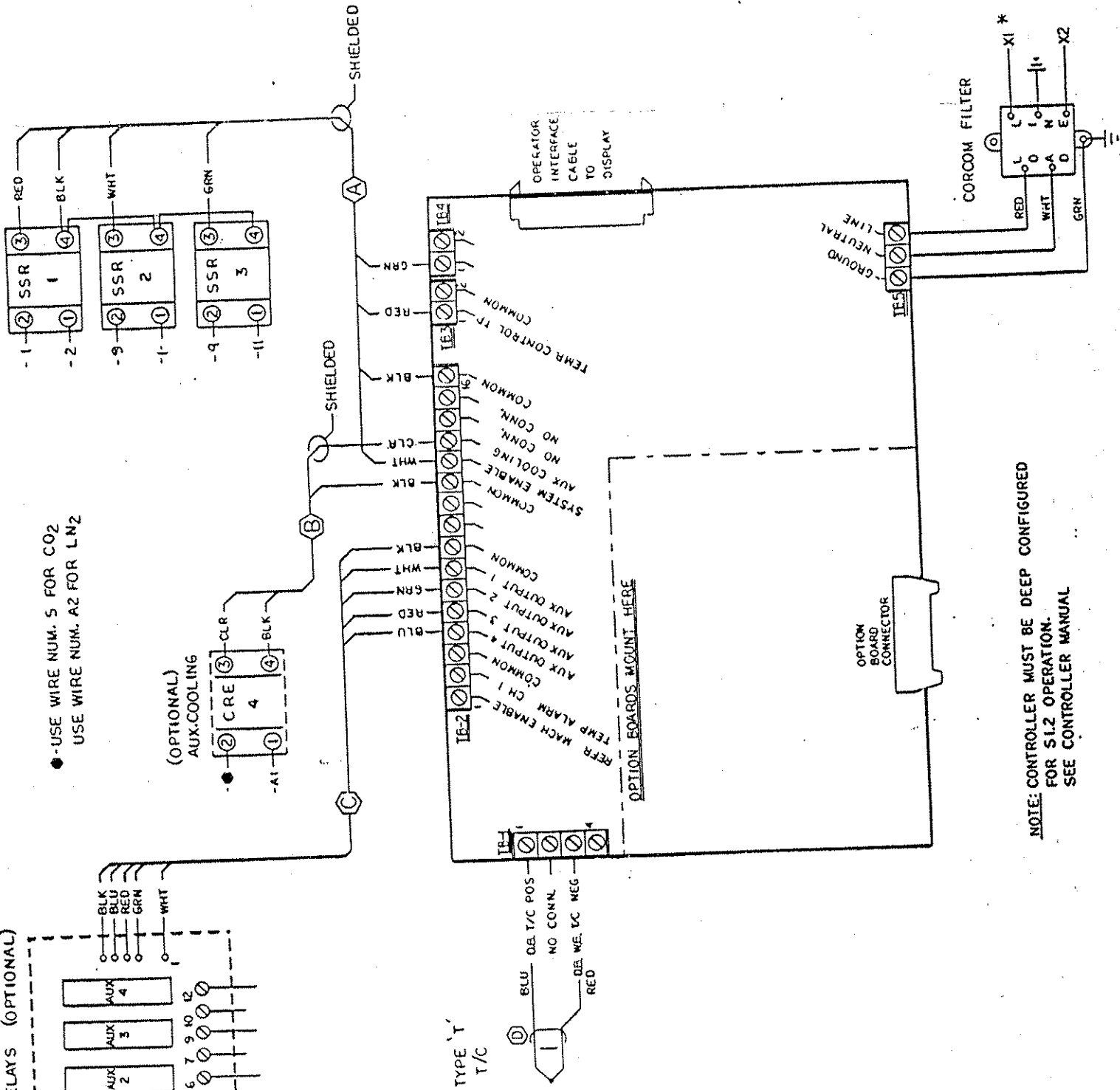

NOTE: CONTROLLER MUST BE DEEP CONFIGURED FOR S1.2 OPERATION. SEE CONTROLLER MANUAL

OPTION BOARD

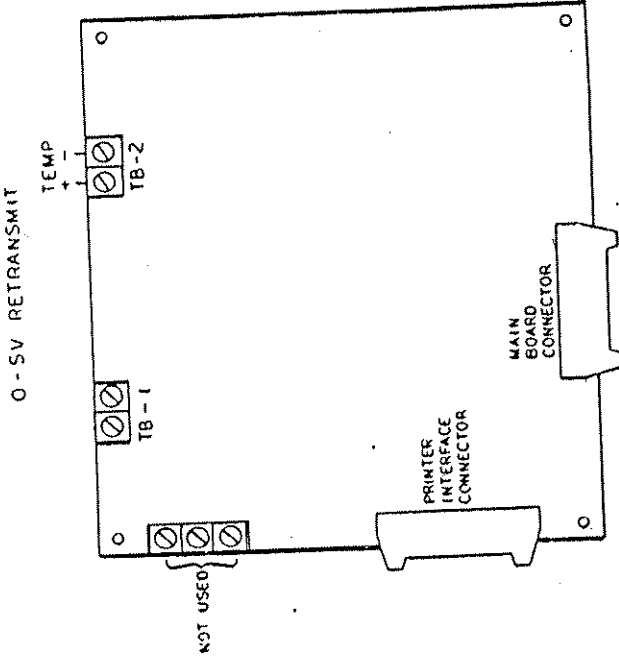

THERMOTRON

The path design on this unit incorporates protection devices. The CONFIDENTIAL TRADE SECRETS OF THERMOTRON INDUSTRIES. Access to this information is RESTRICTED DO NOT use, disclose, publish or copy this information without express authorization.

NO.	CHANGES	DATE	BY	CHK'D	NO.	CHANGES	DATE	BY	CHK'D	TOLERANCE
A	INITIAL BOARD	11-1-76	G	ADD DATE	11-1-76
B	ADD CORCOM FILTER	11-1-76						SCALE
C	NOTE	11-1-76						MATERIAL
D	WIRE CHANGE	11-1-76						FINISH
E						DRAWING NO.
F						DATE

FOR 1-2 CHAMBERS
2800 PROG/CONTROLLER
TERMINAL BLOCK LAYOUT
TEMPERATURE ONLY

DATE: 11-1-76
DRAWING NO.: E5246-12-76
SIZE: W

POWER SUPPLY
115/1/60
15 AMP MAX
20 AMP FUSE RECOMMENDED

1 2 3 4 5 6 7 8 9 10 11 12 13 14 15 16 17 18

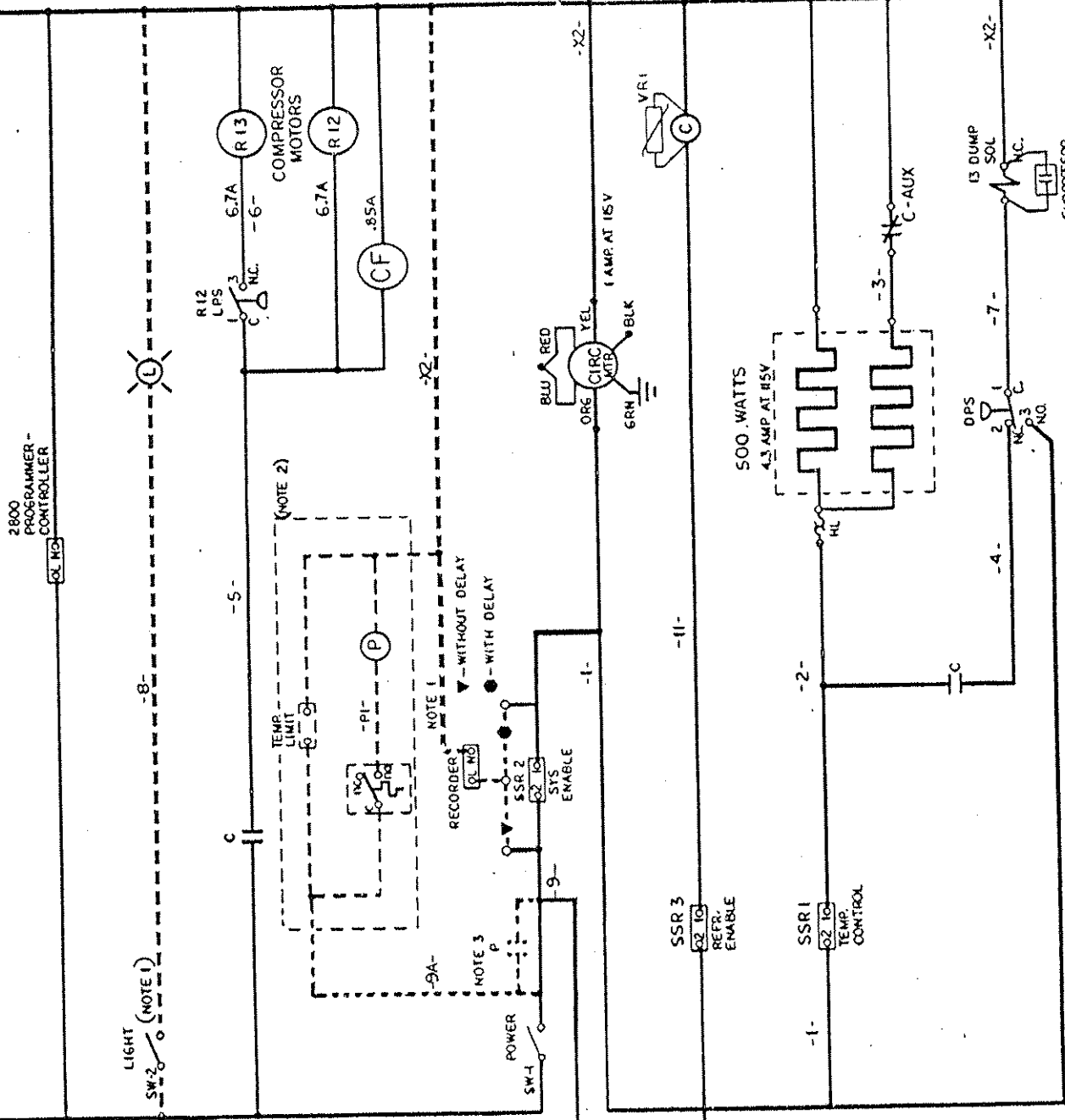

NOTE-1 DOTTED LINES INDICATE OPTIONAL ITEMS.
NOTE-2 TEMP LIMIT OPTION SHOWN IS TO BE USED WITH VERTICAL MODELS ONLY.
NOTE-3 REPLACE WIRE 9 - FROM SWITCH 1 WITH WIRE -9A - WHEN TEMP LIMIT IS USED.

I.2 VERTICAL
TEMP LIMIT OPTIONS

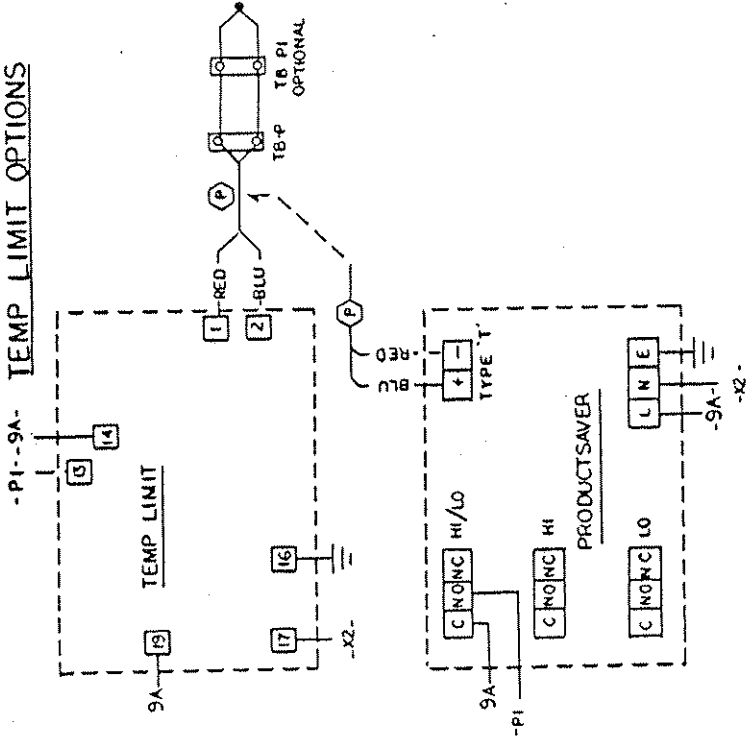

P CONTACTOR
11

COMPRESSOR CONTACTOR
6,15,17

THERMOTRON
The listing on this print represents proprietary designs and CONFIDENTIAL TRADE SECRETS OF THERMOTRON INDUSTRIES. Access to this information is RESTRICTED - DO NOT use, disclose, publish or copy this information without express authorization.
THERMOTRON INDUSTRIES, INC., HOLLAND, MICHIGAN 48623 U.S.A.

NO.	CHANGES	DATE	BY	REASON	NO.	DATE	BY	REASON	NO.	DATE	BY	REASON
1	REMOVE SUPPRESSOR FROM DPS SWITCH	5-15-68	W	REMOVE P CONTACTOR FROM SYS CONTROL	1	5-15-68	W	REMOVE P CONTACTOR FROM SYS CONTROL	1	5-15-68	W	REMOVE P CONTACTOR FROM SYS CONTROL
2	CHANGE WIRE 9A TO WIRE 9	5-15-68	W	CHANGE WIRE 9A TO WIRE 9	2	5-15-68	W	CHANGE WIRE 9A TO WIRE 9	2	5-15-68	W	CHANGE WIRE 9A TO WIRE 9
3	ADD VRI	5-15-68	W	ADD VRI	3	5-15-68	W	ADD VRI	3	5-15-68	W	ADD VRI
4	CHANGE WIRE 9A TO WIRE 9	5-15-68	W	CHANGE WIRE 9A TO WIRE 9	4	5-15-68	W	CHANGE WIRE 9A TO WIRE 9	4	5-15-68	W	CHANGE WIRE 9A TO WIRE 9
5	CHANGE WIRE 9A TO WIRE 9	5-15-68	W	CHANGE WIRE 9A TO WIRE 9	5	5-15-68	W	CHANGE WIRE 9A TO WIRE 9	5	5-15-68	W	CHANGE WIRE 9A TO WIRE 9
6	CHANGE WIRE 9A TO WIRE 9	5-15-68	W	CHANGE WIRE 9A TO WIRE 9	6	5-15-68	W	CHANGE WIRE 9A TO WIRE 9	6	5-15-68	W	CHANGE WIRE 9A TO WIRE 9
7	CHANGE WIRE 9A TO WIRE 9	5-15-68	W	CHANGE WIRE 9A TO WIRE 9	7	5-15-68	W	CHANGE WIRE 9A TO WIRE 9	7	5-15-68	W	CHANGE WIRE 9A TO WIRE 9
8	CHANGE WIRE 9A TO WIRE 9	5-15-68	W	CHANGE WIRE 9A TO WIRE 9	8	5-15-68	W	CHANGE WIRE 9A TO WIRE 9	8	5-15-68	W	CHANGE WIRE 9A TO WIRE 9
9	CHANGE WIRE 9A TO WIRE 9	5-15-68	W	CHANGE WIRE 9A TO WIRE 9	9	5-15-68	W	CHANGE WIRE 9A TO WIRE 9	9	5-15-68	W	CHANGE WIRE 9A TO WIRE 9
10	CHANGE WIRE 9A TO WIRE 9	5-15-68	W	CHANGE WIRE 9A TO WIRE 9	10	5-15-68	W	CHANGE WIRE 9A TO WIRE 9	10	5-15-68	W	CHANGE WIRE 9A TO WIRE 9
11	CHANGE WIRE 9A TO WIRE 9	5-15-68	W	CHANGE WIRE 9A TO WIRE 9	11	5-15-68	W	CHANGE WIRE 9A TO WIRE 9	11	5-15-68	W	CHANGE WIRE 9A TO WIRE 9
12	CHANGE WIRE 9A TO WIRE 9	5-15-68	W	CHANGE WIRE 9A TO WIRE 9	12	5-15-68	W	CHANGE WIRE 9A TO WIRE 9	12	5-15-68	W	CHANGE WIRE 9A TO WIRE 9
13	CHANGE WIRE 9A TO WIRE 9	5-15-68	W	CHANGE WIRE 9A TO WIRE 9	13	5-15-68	W	CHANGE WIRE 9A TO WIRE 9	13	5-15-68	W	CHANGE WIRE 9A TO WIRE 9
14	CHANGE WIRE 9A TO WIRE 9	5-15-68	W	CHANGE WIRE 9A TO WIRE 9	14	5-15-68	W	CHANGE WIRE 9A TO WIRE 9	14	5-15-68	W	CHANGE WIRE 9A TO WIRE 9
15	CHANGE WIRE 9A TO WIRE 9	5-15-68	W	CHANGE WIRE 9A TO WIRE 9	15	5-15-68	W	CHANGE WIRE 9A TO WIRE 9	15	5-15-68	W	CHANGE WIRE 9A TO WIRE 9
16	CHANGE WIRE 9A TO WIRE 9	5-15-68	W	CHANGE WIRE 9A TO WIRE 9	16	5-15-68	W	CHANGE WIRE 9A TO WIRE 9	16	5-15-68	W	CHANGE WIRE 9A TO WIRE 9
17	CHANGE WIRE 9A TO WIRE 9	5-15-68	W	CHANGE WIRE 9A TO WIRE 9	17	5-15-68	W	CHANGE WIRE 9A TO WIRE 9	17	5-15-68	W	CHANGE WIRE 9A TO WIRE 9
18	CHANGE WIRE 9A TO WIRE 9	5-15-68	W	CHANGE WIRE 9A TO WIRE 9	18	5-15-68	W	CHANGE WIRE 9A TO WIRE 9	18	5-15-68	W	CHANGE WIRE 9A TO WIRE 9

DESCRIPTION
S1-2C
ELECTRICAL SCHEMATIC
2800
DATE 3-1-65
DRAWING NO. E5246-12-75
DATE 5-15-68
DRAWN BY C. D.
CHECKED BY
RELEASED BY

THERMOTRON

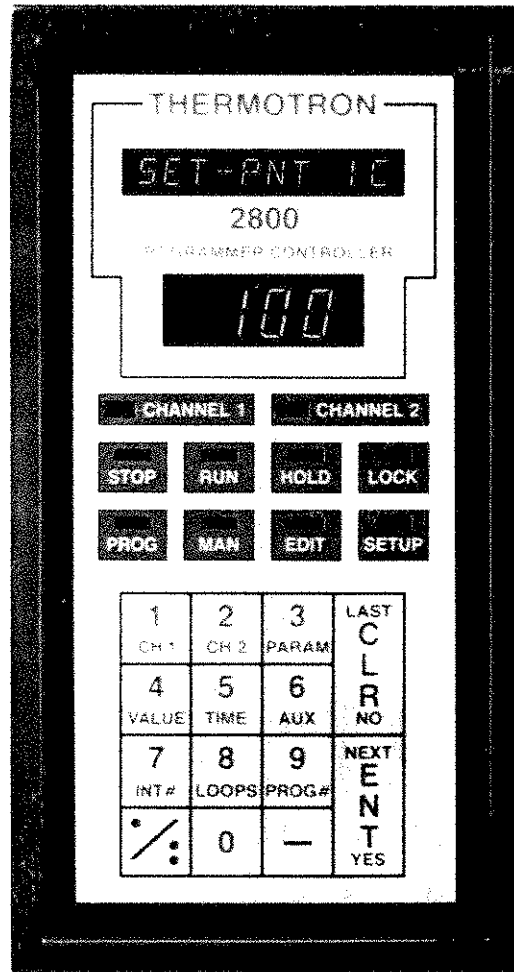

Note:
For Hard Reset
Hold hidden X &
Y buttons in
then plug-in.
It should come up
stating RAM OK.
Unplug chamber
Then plug it
back in.

This manual has important information for the safe operation of this instrument. Read this manual carefully and tell all operators to read this manual. If you do not follow the instructions, you can cause an injury or damage to the equipment, the product, and the building.

2800 PROGRAMMER/CONTROLLER OPERATOR MANUAL

For new manuals contact:

THERMOTRON INDUSTRIES, 291 Kollen Park Drive, Holland, Michigan 49423 U.S.A.
Phone: (616) 392-1491 TWX 810-292-6164 FAX (616) 392-5643

2800 PROGRAMMER/CONTROLLER

TABLE OF CONTENTS

SAFETY INSTRUCTIONS	1
SPECIFICATIONS	2
2800 PROGRAMMER/CONTROLLER	3
THE CONTROLS	4 and 5
THE CHAMBER FUNCTIONS CONTROLLED BY THE 2800	6 and 7
HOW TO OPERATE	
How to Operate in Manual Mode	8 and 9
How to Set the Alarms	10, 11, 12, and 13
What Happens In an Alarm Condition	14
HOW TO PROGRAM	
How to Set the Program Options	15
How to Enter a New Program	16 through 21
How to Program Looping	22
How to Review or Edit a Program	23
How to Run a Program	24
How to Hold or Suspend a Program	25 and 26
How to Delete One Program	27
How to Delete All Programs	28
HOW TO READ THE ALPHA AND NUMERIC DISPLAYS	29, 30, and 31
HOW TO EDIT THE DATA VALUES	32
THE DATA VALUES	33
HOW TO LOCK AND UNLOCK THE KEYBOARD (Removable)	33A
HOW TO USE THE STOP CODE	34
HOW TO CALIBRATE LOW VOLTAGE	35 and 36
HOW TO ADJUST THE 2800	
How to Tune the Proportional Band	37, 38, and 39
How to Tune the Integral Time Setting	40, 41, and 42
How to Calibrate the 2800	43 through 49
The Terminal Block Connections on the Main Board	50

THE OPTIONAL FEATURES

THE MULTIOPTION BOARD OPTION	51
How to Set the Time and the Date on the Real-time Clock	52
How to Program the Delayed Start	53 and 54
The RS-232 Serial Printer Interface Connections	55
When Data Goes to the Printer	56
The Format of the Data Sent to the Printer	56
THE COMPUTER INTERFACE BOARD OPTION	57
The Commands	57
The 2800 Programming Guide (Removable)	57 A
The Control Group Commands	58
The Dump Group Commands	59 and 60
The Load Group Commands	61 and 62
How to Decode the Status Byte	63
How to Decode the Alarm Status Byte	64
How to Use the Service Request (SRQ) Byte	65
What the Error Codes Mean	66, 67, and 68
The GPIB Interface Board	
How the GPIB Interface Functions are Used by the 2800	69 and 70
How to Use the GPIB Configuration Switch	71
What the GPIB Light Emitting Diodes Mean	72
The RS-232 Interface Board	
How to Use the RS-232 Interface	73
What the RS-232 Light Emitting Diodes Mean	74
THE SAMPLE PROGRAMS	APPENDIX A

SAFETY INSTRUCTIONS

For the safe operation of this instrument, read and follow all warnings and cautions. Look for these symbols:

 **WARNING:** If you do not follow the instructions in a **WARNING**, injury can occur to you or to other personnel.

 **CAUTION:** If you do not follow the instructions in a **CAUTION**, damage can occur to the equipment.

 1. You must have training in the operation of this instrument before using it. **Read the instruction manual.**

 2. Do not operate this instrument unless it is completely assembled.

 3. Maintenance and repairs must be done by authorized personnel only. Make calibrations according to the specifications given in this manual.

 4. Use a mild soap and water solution to clean the control panel of the instrument.

 5. To prevent electrical shock, do not touch the transformer and terminal block TB5 on the main board.

 6. To prevent damage to the instrument, do not connect AC power to the terminal blocks on the main board and the multioption board.

 7. Always use an electrical supply system with a separate electrical ground conductor. For maximum protection against electrical shock, use a circuit that is protected by a ground fault circuit interrupter.

SPECIFICATIONS

OPERATING TEMPERATURE:	0°C to +50°C (+32°F to +122°F).
POWER REQUIREMENTS:	117 volts AC ±10%, 50/60 hertz, 23.2 volts amperes.
CHANNELS:	One or two independently programmable channels.
TEMPERATURE RANGE:	-87°C to +190°C (-125°F to +375°F).
HUMIDITY RANGE:	20% to 100% relative humidity.
INPUT:	Type "T" thermocouple (copper/constantan).
SAMPLING RATE:	Process sampled every 0.05 seconds.
MEASURING ACCURACY:	0.25% of span typical.
TEMPERATURE SCALE:	Celsius or Fahrenheit.
SETPOINT/DISPLAY RESOLUTION:	1°Celsius or Fahrenheit, 1% relative humidity.
CONTROL METHOD:	Digital P.I. algorithm, unidirectional (heat only.)
PROPORTIONAL BAND:	Programmable 1 to 1000 units.
INTEGRAL TIME (Automatic Reset):	Programmable 10 to 1000 seconds or off.
OUTPUTS:	Time proportioning self-adjusting, analog 0-5 volts.
MACHINERY CYCLE TIME:	Software controlled.
AUXILIARY COOLING OUTPUT:	Programmable, 0 to 100% of 5 second time frame (channel 1 only.)
ALARM OUTPUTS:	Programmable, one process or one deviation for each channel, on/off TTL compatible. The alpha display flashes.
EVENTS OUTPUTS:	4 on/off TTL compatible. Independently programmable for each interval, or manually.
INTERVALS:	greater than 120.
INTERVAL LENGTH:	1 minute to 24 hours. 1 minute resolution.
PROGRAMS:	Up to 10. Intervals can be divided between programs.
LOOPS:	Up to 16 loops per program. Each loop can be repeated 255 times. Nesting of loops allowed.
PROGRAM MEMORY:	RAM. Dynamically allocated by program number up to maximum number of intervals. Lithium battery back-up to 7 years without power. Battery shelf life 10 years.
COLD JUNCTION COMPENSATION:	Temperature stability better than ±0.05% of span/°C from ambient over operating range.
OPEN THERMOCOUPLE PROTECTION:	Deactivates all outputs. The alpha display shows "OPEN T/C".
OPTIONAL ACCESSORIES:	

Multioption Board

- Real-time clock
- Analog process variable retransmit
- Printer output: RS-232 "talk only" port

Computer Interface Board

- RS-232 or GPIB (IEEE-488, 1978 standard)

Solid State Relay Board

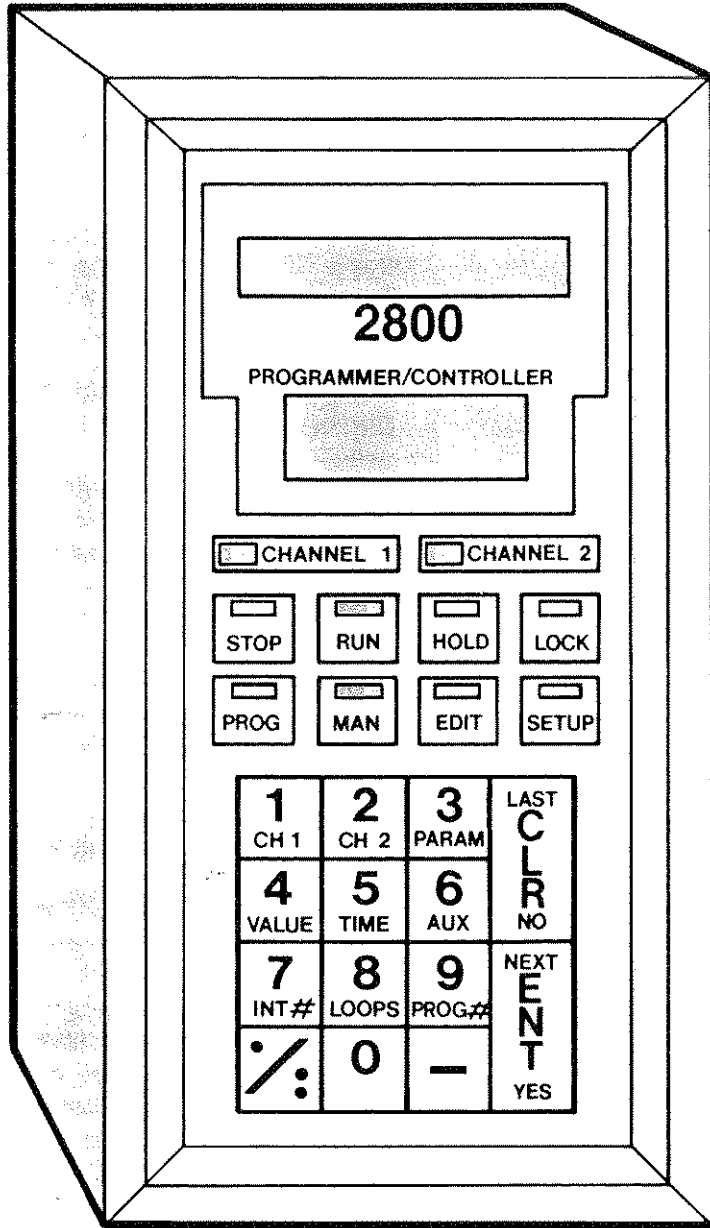

2800 PROGRAMMER/CONTROLLER

The 2800 Programmer/Controller is a programmer and a controller combined. The 2800 Programmer/Controller is specifically designed for use with Thermotron chambers. It has either one channel for the control of temperature or two channels for the control of temperature and direct percent relative humidity. The 2800 features a keypad, an alpha display for English language prompts, and a numeric display for data.

The 2800 Programmer/Controller can be equipped with option boards that increase the features and provide communication with other computers.

THE CONTROLS

The operator controls for the 2800 Programmer/Controller are on either the front or the side of a chamber or on a separate console. The controls consist of the alpha display, the numeric display and the keypad.

THE ALPHA DISPLAY

The alpha display (1) is on the top of the interface panel. This fourteen segment by ten character display is for English language prompts. See Figure 1.

THE NUMERIC DISPLAY

The numeric display (2) is below the alpha display. This display is a 4-digit display for numbers. A decimal point between the second and third digits separates hours and minutes or months and days.

THE KEYPAD

The keypad (3) allows the operator to program the equipment. The keypad contains the following keys:

The **STOP** key stops the functions of the 2800. It is also used to stop the program mode and the setup mode. The **STOP** key is used to display the stop code.

The **RUN** key starts the controller action in either the manual mode or the programmed mode.

The **HOLD** key holds a running program.

The **LOCK** key locks the keyboard from unauthorized use.

The **PROG** key starts the program mode or the review mode. This key is also used with the **RUN** key to run a program.

The **MAN** key is used with the **RUN** key to operate in the manual mode.

The **EDIT** key is used to edit program values.

Continued on the next page.

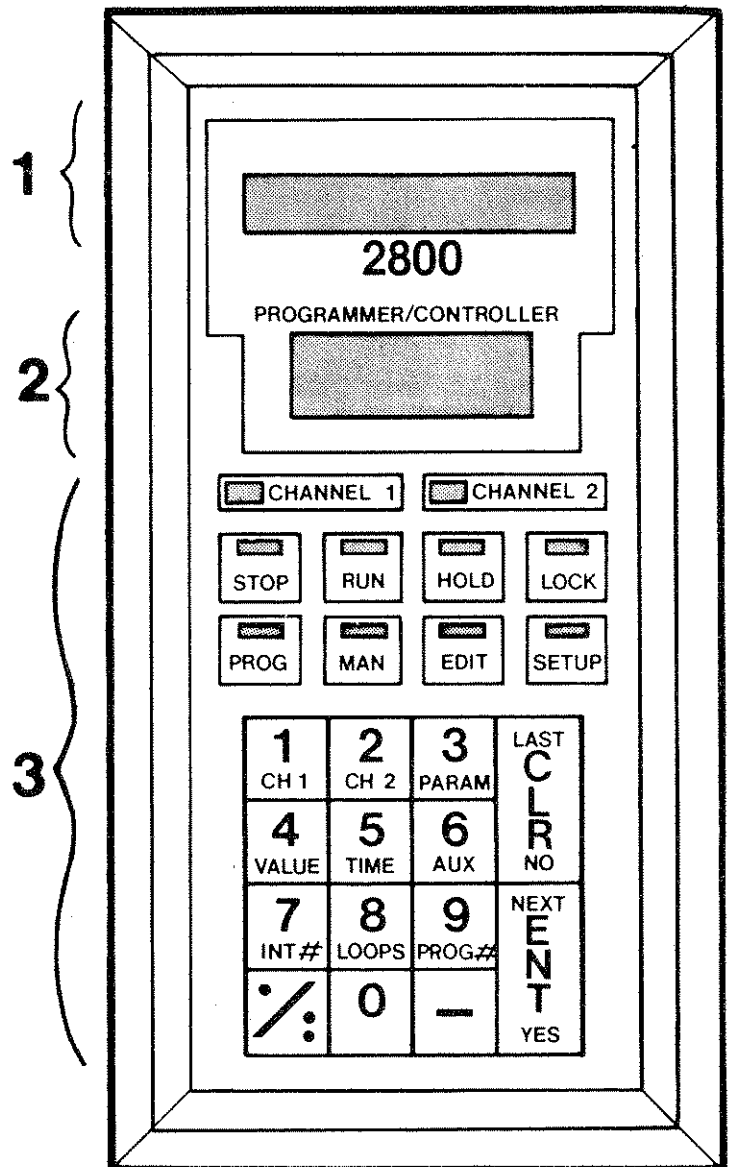

FIGURE 1

The **SETUP** key starts the setup mode.

The **CLR** (NO, LAST) key cancels the last numeric entry, answers NO to yes/no questions, and scrolls backward through the display data group.

The **ENT** (YES, NEXT) key completes a numeric data entry, answers YES to yes/no questions, and scrolls forward through the display data group.

The **0** through **9** keys, the **./:** key and **-** key are for numeric input and to select needed data.

The **X** and **Y** keys are hidden under the interface panel. These keys are used for locking and unlocking the keyboard and for accessing the setup mode.

THE CHAMBER FUNCTIONS CONTROLLED BY THE 2800

The 2800 is a proportional integral controller for heat only control. The 2800 is able to control chambers with refrigeration systems, auxiliary cooling systems, and humidity systems.

The 2800 does not allow the chamber to function if the alpha display shows - OPEN T/C -. To correct the problem, do the following procedure:

1. If the alpha display shows - OPEN T/C -, check the connections on TB1 on the main board. See Figure 2.
2. If the connections are all correct, calibrate the unit. See Page 42.

The 2800 starts the refrigeration system when the following conditions exist:

1. The setpoint is less than or equal to $+122^{\circ}\text{F}$ ($+50^{\circ}\text{C}$).*
 2. The process variable is one degree greater than the setpoint and the heat throttle output is zero.
 3. A negative temperature change is called for while a program is running.
- * If the temperature is less than the setpoint minus the proportional band, a heating command exists.

NOTE: There is a two minute delay between the time the 2800 signals the refrigeration system off and when the refrigeration system shuts off. After a power failure, there is a one minute delay before the refrigeration system starts.

Continued on the next page.

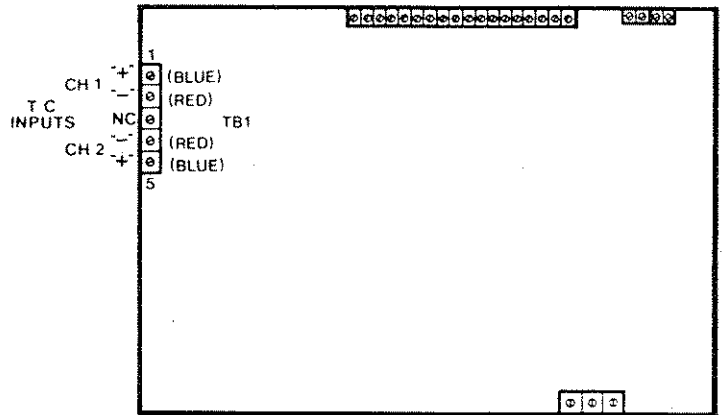

FIGURE 2

The 2800 controls the auxiliary cooling system (LN₂ or CO₂ boost) when the following conditions exist:

1. The refrigeration system is on.
2. The heat throttle is 0.
3. The auxiliary cooling duty cycle is not zero. To adjust the auxiliary cooling duty cycle, change the percent in the AUX CLG parameter. See Page 30.
 - a. A percent of zero shuts the auxiliary cooling system off.
 - b. A percent of 100 keeps the auxiliary cooling system on all the time, but the conditions in Steps 1 and 2 must be met.
 - c. A percent between zero and 100 indicates the percent "on" time (duty cycle) within a five second time frame, but conditions in Steps 1 and 2 must be met.

The humidity system on chambers is controlled by a unit with two channels in the following way:

1. The humidity system is turned off if the humidity setpoint is zero or the channel one setpoint is outside the range of 0°C through +100°C.
2. The humidity system is controlled and shown in units of percent relative humidity based on channel one temperature (dry bulb temperature) and channel two temperature (wet bulb temperature).

The controller-on output of the 2800 turns the chamber on and off. This function is used to turn the chamber on for a delayed start.

HOW TO OPERATE

HOW TO OPERATE IN MANUAL MODE

To operate in manual mode, follow this procedure:

1. Press the **STOP** key.



2. Press the **RUN** key. The alpha display shows PROG/MAN ?.

A rectangular display box containing the text "PROG/MAN ?".

3. Press the **MAN** key.



4. To set a setpoint, follow this procedure:

a. Press the **VALUE** key until the alpha display shows SET-PNT.

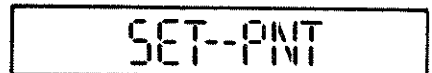
A rectangular display box containing the text "SET-PNT".

b. Press the **CH 1** key. The alpha display shows SET-PNT 1C.

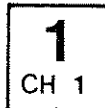
A rectangular display box containing the text "SET-PNT 1C".

c. Press the **EDIT** key. The edit key light illuminates.



d. Press the numeric key(s) for the setpoint value you want.

A rectangular display box containing the number "6".A rectangular display box containing the number "65".

e. Press the **ENT** key. The edit key light stops illuminating.

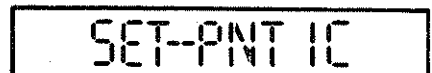
A rectangular display box containing the text "SET-PNT 1C".A rectangular display box containing the number "65".

Continued on the next page.

5. To change a setpoint, follow this procedure:

a. Press the **EDIT** key. The edit key light illuminates.



b. Press the numeric key(s) for the setpoint value you want.



c. Press the **ENT** key. The edit key light stops illuminating.



6. Additional data values can be operated in the manual mode. A complete list of the data values are on Page 33.

HOW TO SET THE ALARMS

If an alarm is needed, the alarm must be set before programming the instrument. The instrument can be programmed to alarm either on the limits of the process variable or on the deviation from setpoint.

To select an alarm, follow this procedure:

1. Press the **SETUP** key. The alpha display shows -- SETUP --.



--SET UP--

2. Press the **Y** key, hidden above the letters TROL between the two displays. The alpha display shows ALARM COND.



ALARM COND

NOTE: The setup mode can be exited at the beginning of a function by pressing the STOP key. The alpha display shows OLD VALUES.

3. Press the **ENT** key. The alpha display shows SET CH1 AL.



SET CH1 AL

NOTE: For a unit with one channel the alpha display shows PROCESS ?. Go to Step 5.

4. If settings are not needed for channel 1, press the **CLR** key. Go to the top of Page 12.

OR

Press the **ENT** key. The alpha display shows PROCESS ?.



PROCESS ?

5. Press the **ENT** key to continue setting the process alarms. The alpha display shows CH1 LO VAL.

OR

Press the **CLR** key to set the deviation alarms. Go to Step 10 on Page 11.



CH1 LO VAL

Continued on the next page.

6. Press the numeric key(s) to select the channel 1 low value.

-	-0
5 TIME	-5
0	-50

7. Press the **ENT** key to store the channel 1 low value. The alpha display shows CH1 HI VAL.

NEXT ENT YES	CH1 HI VAL
--------------------	------------

8. Press the numeric key(s) to select the channel 1 high value.

1 CH 1	1
5 TIME	15
0	150

9. Press the **ENT** key to store the channel 1 high value. Go to the top of Page 12.

NEXT ENT YES

10. The alpha display shows DEVIATION.

DEVIATION

11. Press the **ENT** key to set the deviation alarm. The alpha display shows CH1 DV-BND. Use positive values only.

OR

Press the **CLR** key to not set the deviation alarm.

NEXT ENT YES	CH1 DV-BND
	0

For units with one channel, the alpha display shows OK TO SAVE. Go to Step 24 on Page 13.

For units with two channels, the alpha display shows SET CH2 AL.

14. If settings are not desired for channel 2, press the CLR key. Go to Step 23 on Page 13.

OR

Press the ENT key. The alpha display shows PROCESS ?.

15. Press the ENT key to continue setting the process alarms. The alpha display shows CH2 LO VAL.

OR

Press the CLR key to set the deviation alarms. Go to Step 20 on Page 13.

16. Press the numeric key(s) to select the channel 2 low value.

17. Press the ENT key to store the channel 2 low value. The alpha display shows CH2 HI VAL.

18. Press the numeric key(s) to select the channel 2 high value.

Continued on the next page.

OK TO SAVE

SET CH2 AL

NEXT
ENT
YES

PROCESS ?

NEXT
ENT
YES

CH2 LO VAL

3
PARAM

3

0

30

NEXT
ENT
YES

CH2 HI VAL

9
PROG#

9

5
TIME

95

19. Press the **ENT** key to store the channel 2 high value. Go to Step 23.

NEXT
E
N
T
YES

20. The alpha display shows DEVIATION.

DEVIATION

21. Press the **ENT** key to set the deviation alarm. The alpha display shows CH2 DV-BND. Use positive values only.

NEXT
E
N
T
YES

CH2 DV-BND

OR

Press the **CLR** key to not set the deviation alarm. Go to Step 23.

22. Press the numeric key(s) to select the channel 2 deviation band value.

5
TIME

5

23. Press the **ENT** key if values are correct. The alpha display shows OK TO SAVE.

NEXT
E
N
T
YES

OK TO SAVE

24. Press the **CLR** key if an error was made. The alpha display shows OLD VALUES.

OR

Press the **ENT** key. The alpha display shows -- SAVING --.

NEXT
E
N
T
YES

-- SAVING --

WHAT HAPPENS IN AN ALARM CONDITION

When the instrument detects a process alarm, the alpha display flashes and the output terminal goes **HIGH**. The 2800 stops the test while the alarm condition exists.

When the instrument detects a deviation from the setpoint, the alpha display flashes and the output terminal goes **HIGH**. The 2800 does not stop the test.

HOW TO PROGRAM

HOW TO SET THE PROGRAM OPTIONS

The 2800 program options can be turned on or off according to your needs. Some of the following steps do not apply if your programmer/controller is only a one channel unit.

To set the program options, follow this procedure:

1. Press the **SETUP** key. The alpha display shows --SETUP--.



--SET UP--

2. Press the **PROG** key. If the 2800 is a two channel unit, the alpha display shows CHAN 2 OFF or CHAN 2 ON.



CHAN 2 ON

3. Press the **CLR** key until the needed setting shows in the alpha display. If you do not need channel two prompts, select CHAN 2 OFF.



CHAN 2 OFF

4. Press the **ENT** key. The alpha display shows AUX OFF or AUX ON.



AUX 1 OFF

5. Press the **CLR** key until the needed setting shows in the alpha display.



6. Press the **ENT** key.



HOW TO ENTER A NEW PROGRAM

The 2800 Programmer/Controller has storage for ten different programs. The programs are numbered 1 through 10.

To enter a new program, follow this procedure:

1. Press the **STOP** key.
2. Press the **PROG** key. The alpha display shows **PROG NMBR**. The 2800 selects the lowest available program number.
3. Press either the **ENT** key to select the program number chosen by the 2800 or press a numeric key(s) to select an unused program number. The alpha display shows **INIT VAL 1**.
4. If you want to change the initial values for channel 1, press the numeric key(s) to select a new initial value. The initial value then becomes the primary setpoint.
 - a. The following key(s) are helpful in selecting the initial value:
 1. The "-" key can be pressed at any time during the process. The "-" key either changes a negative value to a positive value or a positive value to a negative value.
 2. The **CLR** key resets the numeric display value to 0.
5. When the initial value is correct, press the **ENT** key.

For units with one channel, go to Step 8 on Page 17.

For units with two channels, the alpha display shows **INIT VAL 2**.

Continued on the next page.



PROG NMBR



INIT VAL 1

21

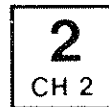

2



25



INIT VAL 2

0

6. Press the numeric key(s) to select the initial value for channel two. The initial value then becomes the primary setpoint for channel two.

2
CH 2

2

a. The following key(s) are helpful in selecting the initial value:

5
TIME

25

1. The "-" key can be pressed at any time during the process. The "-" key either changes a negative value to a positive value or a positive value to a negative value.

2. The **CLR** key resets the numeric display value to 0.

7. When the initial value is correct, press the **ENT** key.

NEXT
ENT
YES

INTERVAL

8. After the initial value(s) have been selected, the alpha display shows **INTERVAL** and the numeric display shows 1.

1

9. Press the **ENT** key to continue programming. The alpha display shows **FINL VAL 1**.

NEXT
ENT
YES

FINL VAL 1

10. Press the numeric key(s) to select the final value for channel one.

6
AUX

6

5
TIME

65

11. When the final value is correct, press the **ENT** key.

NEXT
ENT
YES

FINL VAL 2

For units with one channel, go to Step 14.

For units with two channels, the alpha display shows FINL VAL 2.

12. Press the numeric key(s) to select the final value for channel two.



13. When the final value is correct, press the ENT key.



14. After the final values have been selected, the alpha display shows INTVL TIME. The unit needs to know how long the interval will be. After the time is selected, press the ENT key.

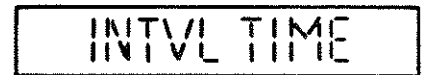

a. The maximum interval time is 24 hours, 59 minutes. To set the time, do the following:

1. Press the numeric key(s) to select the hours.

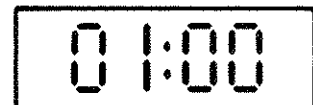
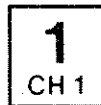

2. Press the ./: key to separate the hours and the minutes.



3. Press the numeric keys to select the minutes. Go to Step 15 on Page 20.



Continued on the next page.

b. If the time of 00.00 is selected, a soak period is used on the next interval. The program time is held until the process variable is within the indicated deviation from the setpoint. This is the continue deviation setting.

1. The alpha display shows CONT DEV-1 for channel 1.

2. Press the numeric key(s) to select the continue deviation setting.

a. The continue deviation numbers are in the range 0 to 15.

b. Only positive numbers can be selected.

c. If 0 is selected, the program continues to the next interval.

d. If any channel is preset to wait, the 2800 holds the program timer until that channel is within the selected deviation.

For units with one channel, go to Step 15 on Page 20.

For units with two channels, the alpha display shows CONT DEV-2.

3. Press the numeric key(s) to select the continue deviation setting.

a. The continue deviation numbers are in the range 0 to 15.

b. Only positive numbers can be selected.

c. If 0 is selected, the program continues to the next interval.

d. If any channel is preset to wait, the 2800 holds the program timer until that channel is within the selected deviation.

NEXT
E
N
T
YES

INTVL TIME

00:00

CONT DEV-1

1
CH 1

|

NEXT
E
N
T
YES

CONT DEV-2

1
CH 1

|

NEXT
E
N
T
YES

15. Press the **ENT** key. The alpha display shows AUXILIARY.

NEXT
E
N
T
YES

AUXILIARY

16. Press the numeric keys 1 through 4 to select the auxiliary(s).

2
CH 2

-2-

OR

To cancel the auxiliary(s), press the **CLR** key and select again or go to the next step.

4
VALUE

-2-4

17. Press the **ENT** key. The alpha display shows NEXT INT ?.

NEXT
E
N
T
YES

NEXT INT?

18. To choose looping, see Page 22.

OR

Press the **ENT** key. The alpha display shows INTERVAL and the next interval number to be programmed.

NEXT
E
N
T
YES

INTERVAL

19. Press the **ENT** key to continue programming. The alpha display shows FINL VAL 1. The numeric display shows the final value of the previous interval which is used as the initial value for the next interval. Repeat Steps 10 through 19.

NEXT
E
N
T
YES

FINL VAL 1

65

OR

Press the **STOP** key to stop programming. If the **ENT** key is not pressed in Step 17, the unit deletes the last interval programmed. The alpha display shows - INT LEFT - and the numeric display shows the number of intervals remaining in storage.

Continued on the next page.

20. After 2 seconds, the 2800 returns to the stop state. The program can now be reviewed, edited, or run.

NOTE: If the alpha display shows OUT OF MEM, the 2800 stops programming. To continue programming, delete one or more programs from the memory. The 2800 stores what has been programmed up to when the alpha display showed OUT OF MEM. See Page 27, **How to Delete One Program.**



-INT LEFT-

126

HOW TO PROGRAM LOOPING

Looping is sending the program back to a previous interval or target interval.

To program the 2800 to do looping, follow this procedure:

1. The alpha display shows NEXT INT ?.
2. Press the numeric key(s) to select which interval is the target for the loop.
 - a. The following rules apply when looping. See Figure 3.
 1. The target interval must be less than or equal to the current interval.
 2. The target interval must not be within any other loop unless it is the target for that loop.
 3. Loops can be nested. The maximum number of loops per program is 16.
 4. The final value of the looping interval must be the same as the final value of the interval which precedes the target interval.

NEXT INT ?

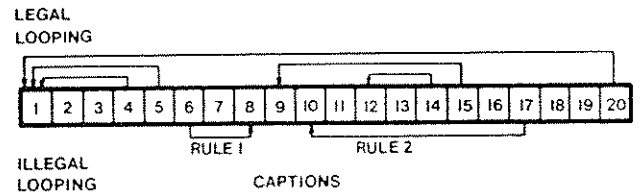

FIGURE 3

3. Press the ENT key. When a loop has been programmed, the alpha display shows NMBR LOOPS.
4. Press the numeric key(s) to select how many loops are needed.
 - a. A loop can be repeated 255 times.
5. Press the ENT key. The alpha display shows INTERVAL. The numeric display shows the next interval number.

NEXT
ENT
YES

NMBR LOOPS

NEXT
ENT
YES

INTERVAL

Return to Step 19 on Page 20.

HOW TO REVIEW OR EDIT A PROGRAM

To either review or edit a program, follow this procedure:

1. Press the **STOP** key.
2. Press the **PROG** key. The alpha display shows PROG NMBR.
3. Press the numeric key(s) to select the number of the program to be reviewed or edited.
4. Press the **ENT** key. If the program selected exists, the alpha display shows PROG/EDIT.
5. Press the **ENT** key. The alpha display shows INTV NMBR and the number display shows 1.

NOTE: If an interval number other than interval number 1 is entered, that interval must exist. If it does not, the alpha display shows NO INTRVL. If any looping targets are changed and they affect a loop rule later in the program, the 2800 prompts to delete the affected loop.

6. Press the **ENT** key to review or edit interval number 1.

OR

Press the number key(s) to select the interval to be reviewed or edited. Press the **ENT** key.

7. Press the **ENT** key to scroll through an existing program.
 - a. If the value in the numeric display is correct, press the **ENT** key.
 - b. To change a value, press the numeric key(s) to select the needed value. Press the **ENT** key.
 - c. When the edit light stops illuminating, additional intervals can be added. The 2800 is in the program mode.
8. Pressing the **STOP** key at any time during the review and edit function returns the 2800 to the stop state. The number of intervals left in memory are shown in the numeric display.

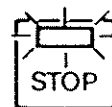
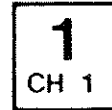

PROG NMBR

1

INTV NMBR

1

-INT LEFT-

254

HOW TO RUN A PROGRAM

To run a program, follow this procedure:

1. Press the **STOP** key.



2. Press the **RUN** key. The alpha display shows PROG/MAN ?.



PROG/MAN ?

3. Press the **PROG** key. The alpha display shows PROG NMBR.



PROG NMBR

4. Press the numeric key(s) to select the program to be run.

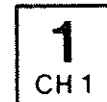

|

5. Press the **ENT** key. The alpha display shows INTV NMBR.



INTV NMBR

6. Press the numeric key(s) to select the starting interval.

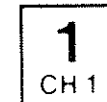

|

7. Press the **ENT** key to start the program.

- a. If the instrument is equipped with the multioption board, the alpha display shows DLYD START. See Steps 8 through 11 on Page 54.



HOW TO HOLD OR SUSPEND A PROGRAM

While a program is running, the program can be put in the hold state or the suspended state. The hold state allows data values to be edited for one interval; the remaining data values are not changed. The suspended state allows the running program to be temporarily suspended and run in the manual mode.

To hold a program, follow this procedure:

1. Press the **HOLD** key. All program values are kept. The program holds at the current interval and stops the time left in the interval.



2. If it is necessary to change program data values, follow this procedure:

a. Decide which data value you want to edit. See Page 33 for a list of the data values.

b. Press the group key until the data value shows in the alpha display. See Pages 29, 30, and 31 for a list of the group keys.



c. Press the **EDIT** key. If the edit key light illuminates, the data value can be edited.



d. Press the numeric key(s) to select the new value.



e. Press the **ENT** key.



3. To continue the program, press the **RUN** key.



To suspend a program, follow this procedure:

1. Press the **HOLD** key. All program values are kept. The program holds at the current interval and stops the time left in the interval.



2. Press the **MAN** key. The 2800 can be run manually without changing the "program" data values or the program position.



3. If it is necessary to change any data values, follow this procedure:

a. Decide which data value you want to edit. See Page 33 for a list of the data values.

b. Press the group key until the data value shows in the alpha display. See Pages 29, 30, and 31 for a list of the group keys.



c. Press the **EDIT** key. If the edit key light illuminates, the data value can be edited.



d. Press the numeric key(s) to select the new value.

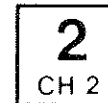

e. Press the **ENT** key.



4. To return to the hold program mode, press the **PROG** key. You can now change "program" data values.



5. To continue the program, press the **RUN** key.



HOW TO DELETE ONE PROGRAM

To delete one program, follow this procedure:

1. Press the **PROG** key. The alpha display shows **PROG NMBR**.
2. Select the numeric key(s) of the program to be deleted.
3. Press the **ENT** key. The alpha display shows **PROG/EDIT**.
 - a. To cancel the program delete function, follow this procedure:
 1. Press the **CLR** key.
 2. Press the **STOP** key.
4. Press the **PROG** key. The alpha display shows **INI VAL 21**. The program has been deleted.



PROG NMBR

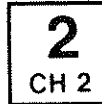

2



PROG/EDIT



INI VAL 21

HOW TO DELETE ALL PROGRAMS

To delete all programs, follow this procedure:

1. Press the **PROG** key. The alpha display shows PROG NMBR.
2. Press the numeric **0** key.
3. Press the **ENT** key. The alpha display shows DEL ALL ??.
 - a. To cancel the delete all function, follow this procedure:
 1. Press the **CLR** key.
 2. Press the **STOP** key.
4. To delete all programs, press the **ENT** key. The alpha display shows PROG NMBR. The numeric display shows 1.



PROG NMBR



0



DEL ALL ??



PROG NMBR

1

HOW TO READ THE ALPHA AND NUMERIC DISPLAYS

When the 2800 is in either the run state or the hold state, the data for the current interval can be shown in the alpha and numeric displays. When the 2800 is in the stop state, the data shown refers to the last interval which was run.

Data is shown in groups. To show the data, follow this procedure:

1. See Step 6 on Pages 30 and 31 to determine which group key to press.
2. Press the group key. The alpha display shows data information from that group.
3. Press the numeric 1 key to show the Channel 1 data.

4
VALUE

Press the numeric 2 key to show the Channel 2 data.

1
CH 1

F-VALUE 1C

2
CH 2

F-VALUE 2H

4. Press the same group key to scroll within the selected group.

4
VALUE

VARIABLE 2P

NOTE: The following information is for the parameter and value groups only.

5. The last letter of the alpha display means the following:

F means degrees in Fahrenheit
C means degrees in Celsius
P means percent output
H means humidity
S means seconds

The second to the last character in the alpha display indicates which channel.

Example: VARIABLE 1 F means the channel 1 variable is in degrees Fahrenheit.

6. The following are the groups and the order they are in. The numeric key is also given.

Channel 1 Selection Numeric key 1

When pressed with another group key, gives the numeric values of channel 1.

Channel 2 Selection Numeric key 2

When pressed with another group key, gives the numeric values of channel 2.

Parameter Group Numeric key 3

THROTTL - The output of the throttle displays as a percent.

PRP-BND - The proportional band setting displays in degrees Fahrenheit, Celsius, or relative humidity.

INTEGRL - Integral time parameter displays in seconds.

AUX CLG - The auxiliary cooling duty cycle displays as a percent.

Value Group Numeric key 4

VARIABLE - The numeric display shows the current process variable for the selected channel.

SET-PNT - The numeric display shows the current setpoint for the selected channel.

DEVIATN - The numeric display shows the actual deviation from the setpoint.

I-VALUE - The numeric display shows the initial value of the setpoint for this interval. This is also the value of the previous interval.

F-VALUE - The numeric display shows the final value of the setpoint for this interval.

Continued on the next page.

Time Group **Numeric key 5**

TIME LEFT - The numeric display shows the time left to go for this interval (HH.MM)

INTVL TIME - The numeric display shows the programmed interval time (HH.MM)

TIME - The numeric display shows the current time in hours and minutes. The time can be set only if the instrument is equipped with the multioption board.

DATE - The numeric display shows the current date as month and day. The date can be set only if the instrument is equipped with the multioption board.

PRNT INT S - The numeric display shows the print interval time in seconds. Print interval time can be set only if the instrument is equipped with the multioption board.

Auxiliary Group **Numeric key 6**

AUX EVENTS - The auxiliary outputs that are programmed for that interval display.

Interval Group **Numeric Key 7**

INTERVAL - The numeric display shows the current interval number.

NXT INTRVL - The numeric display shows the next interval in the program. If the current interval has been programmed to loop, the numeric display shows the target interval.

Loop Group **Numeric key 8**

LOOPS LEFT - If the current interval is within a loop, the numeric display shows the number of loops left. With nested loops, the numeric display shows only the innermost loop.

NMBR LOOPS - The numeric display shows the total number of loops programmed.

Prog # Group **Numeric key 9**

PROGRAM - The numeric display shows the number of the program running.

HOW TO EDIT THE DATA VALUES

The data values shown on Page 33 can be edited while the 2800 is in the stop state, the manual run state, or the program hold state. To edit the data values, follow this procedure:

1. Select the data value to be changed. See Page 33.
2. Press the **EDIT** key. If the data value can be edited from the current state, the EDIT light illuminates.
3. Press the numeric key(s) to select the new data value.
4. Press the **ENT** key. The EDIT light stops illuminating.



THE DATA VALUES

Data Value	Program State	Changes Allowed.
SET-PNT	Stop Run Manual	The setpoint can be changed for each channel.
F-VALUE	Program Hold	The final value for each channel can be changed. This new value becomes the initial value for the next interval.
TIME LEFT	Program Hold	The time remaining in the current interval can be changed.
TIME	Stop Run Manual Program Hold	If the 2800 is equipped with the multioption board, the real time clock can be set by changing the time of day.
DATE	Stop Run Manual Program Hold	If the 2800 is equipped with the multioption board, the date can be changed or set.
PRNT INT	Stop Run Manual Program Hold	If the 2800 is equipped with the multioption board, the time interval for printing can be changed. Remember that 0 seconds means the print trigger is off.
AUX EVENTS	Run Manual Program Hold	The auxiliary outputs can be changed for the current interval. Press the CLR key to cancel all auxiliaries.
LOOPS LEFT	Program Hold	The number of loops remaining to be completed can be changed. For nested loops, only the innermost loop can be changed.
PRP-BND	Stop Run Manual Program Hold	The proportional band can be edited to reach proper control action.
INTEGRL	Stop Run Manual Program Hold	The integral band can be edited to reach proper control action.
AUX CLG	Stop Run Manual Program Hold	The auxiliary cooling duty cycle can be edited to reach proper auxiliary cooling control.

HOW TO LOCK AND UNLOCK THE KEYBOARD

The keyboard can be locked to provide security. The keyboard can be locked in the stop state, the program run/hold state, the manual run state, or the delay start state.

To lock the keyboard, follow this procedure:

1. Press the **LOCK** key. The alpha display shows ENTER KEY.
2. Press the **X** key hidden just above the letters OGRA between the two displays. The alpha display shows -XXX-.
3. Press the **Y** key hidden just above the letters TROL between the two displays. The alpha display shows -XXX--YYY-.
4. Press the **LOCK** key again. The LOCK light illuminates. The keyboard is now locked.

NOTE: The only active keys on the keyboard are those that change the display selection.

To unlock the keyboard, repeat Steps 1 through 4 listed above.



ENTER KEY



-XXX-



-XXX--YYY-



HOW TO USE THE STOP CODE

The stop code is used to know why the 2800 is in the stop mode.

To show the stop code, follow this procedure:

1. Press the **STOP** key. For two seconds the alpha display shows STOP CODE and the numeric display shows the stop code number.
2. Use the chart below to know what the stop code number means.



STOP CODE



STOP CODE NUMBERS

EXPLANATION OF THE STOP CODE NUMBERS

0*	An unidentified error condition exists.
1	The STOP key was pressed.
2	A RAM error has occurred. Check existing programs for data that might have changed. To clear the error, program the 2800 again.
3	The thermocouple on Channel 1 is open.
4	The thermocouple on Channel 2 is open.
5	The temperature limit has been exceeded for the 3.5 bench top model.
6	There is a process alarm on Channel 1.
7	There is a process alarm on Channel 2.
8	A Stop command has been received from the computer interface.
9	The program is finished.
99*	The watch-dog timer detects an error and resets the 2800.

* The stop codes 0 and 99 can be caused by externally generated EMI/RFI electrical noise.

HOW TO RECOVER AFTER LOW VOLTAGE

The 2800 alpha display shows LOW VOLTS when the 2800 detects AC line voltage that is lower than the preset level.

The 2800 remains in the LOW VOLTS state until the line voltage returns to normal.

The LOW VOLTS state does not destroy the memory. When the voltage returns to normal, the 2800 resets and continues with what it was doing.

If the 2800 DOES NOT RESET, follow this procedure:

Equipment needed:

A variable AC power supply
An oscilloscope

1. Check for 115 volts AC $\pm 10\%$ at TB5-2 and TB5-3. If voltage is out of range, correct your line voltage. See Figure 4.
2. If voltage is correct but the alpha display still shows LOW VOLTS, press the X key hidden above the letters OGRA between the two displays to temporarily clear the low voltage condition.
3. Disconnect the line cord. Connect a variable AC power supply to TB5-2 and TB5-3 on the main board.
4. Press the **SETUP** key. The alpha display shows --SETUP--.
5. Press the X key hidden above the letters OGRA between the two displays. The alpha display shows CALIBRATE.
6. Press the X key again. The alpha display shows VOLT CAL.
7. Locate TB2-16 and TP4. See Figure 4. These points provide 5 VDC power on the 2800.

Continued on the next page.

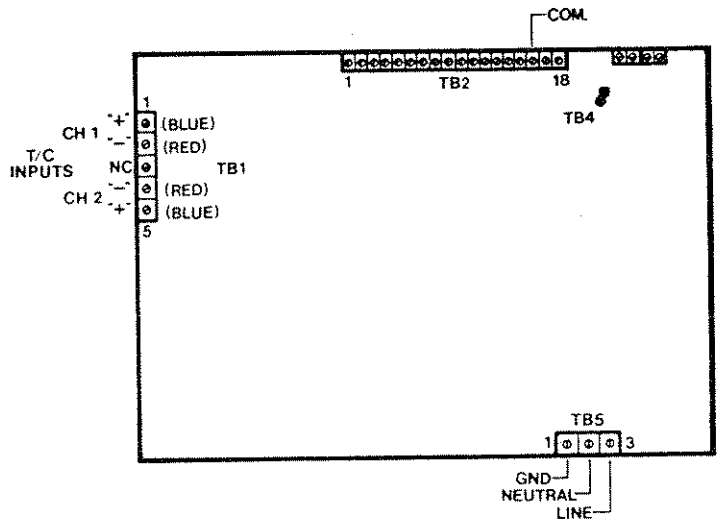
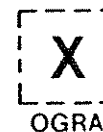
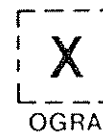
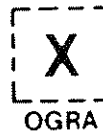

FIGURE 4



8. Attach the ground probe of an oscilloscope to TB2-16. Attach the positive probe of an oscilloscope to TP4.
9. Set the oscilloscope for AC input, 100 millivolt range.
10. Adjust the AC power supply to 115 VAC.
11. Decrease the AC power supply until 100 millivolts of ripple appears on the oscilloscope or the AC voltage is 95.
12. Press the **ENT** key. The alpha display shows -- BUSY -- for 10 seconds. **Do not change the setting while the alpha display shows -- BUSY --.**

NEXT
ENT
YES

--BUSY--

13. When the 2800 has completed the reading, the alpha display shows OK TO SAVE.

OK TO SAVE

14. Adjust the variable AC power supply to a normal operating level.

15. Press the **ENT** key. The alpha display shows -- SAVING --. The 2800 returns to the stop state.

NEXT
ENT
YES

--SAVING--

HOW TO ADJUST THE 2800

As load requirements and other conditions change, the 2800 needs the control settings adjusted. There are two control settings. One setting is the proportional band setting. The other setting is the integral time setting.

HOW TO TUNE THE PROPORTIONAL BAND

The proportional band setting allows the proportional action of the instrument to be adjusted. The units for the proportional band are the same as those for the process variable for the channel. The proportional band has a range of 1 to 1000 units. The proportional band is tuned with the integral function off.

NOTE: In the following procedure, this manual uses 20% when adjusting the proportional band. You can use larger or smaller quantities.

To tune the settings for the proportional band, follow this procedure:

1. Press the **PARAM** key until the alpha display shows INTEGRL 1S.

NOTE: Record the existing value for use in setting the integral time.

2. Press the **EDIT** key.

3. Press the **0** key.

4. Press the **ENT** key. The alpha display shows -- SAVING -- for one second.

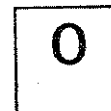
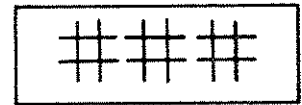

5. Press the **RUN** key. The alpha display shows PROG/MAN?.



PROG/MAN ?

6. Press the **MAN** key.



7. Press the **VALUE** key until the alpha display shows SET-PNT 1C.



SET-PNT 1C

8. Press the **EDIT** key. A setpoint outside the proportional band and below the process variable is 0.



9. Press the **0** key.

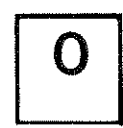

0

10. Press the **ENT** key. The numeric display shows the new setpoint.



SET-PNT 1C

0

Continued on the next page.

11. Press the **CLR** key. The alpha display shows **VARIABLE IC**.



VARIABLE IC

- a. Watch the numeric display to see if the chamber temperature oscillates near the setpoint.
- b. If the chamber temperature oscillates, increase the proportional band by approximately 20%.

1. To increase the proportional band, follow this procedure:

- a. Press the **PARAM** key until the alpha display shows **PRP-BND IC**.



PRP-BND IC

- b. Press the **EDIT** key. Increase the current value by 20%.



- c. Press the **ENT** key. The alpha display shows **--SAVING--**.



--SAVING--

- c. If the temperature never reaches the setpoint, decrease the proportional band by approximately 20%.

1. To decrease the proportional band, follow this procedure:

- a. Press the **PARAM** key until the alpha display shows **PRP-BND IC**.



PRP-BND IC

- b. Press the **EDIT** key. Decrease the current value by 20%.



- c. Press the **ENT** key. The alpha display shows **--SAVING--**.



--SAVING--

The ideal proportional band setting is reached when the temperature within the chamber does not oscillate with minimum droop. Droop is when the temperature within the chamber never reaches the setpoint.

12. Bring the chamber temperature well above the setpoint and repeat Steps 7 through 11 until the chamber reaches proper control.

HOW TO TUNE THE INTEGRAL TIME SETTING (OR PARAMETER)

The integral time setting allows the integral action to be adjusted. Integral time is given in seconds. The integral time has a range of 10 to 1000 seconds. A zero setting stops the integral function.

NOTE: In the following procedure this manual uses 20 seconds when adjusting the integral time setting. You can use larger or smaller quantities.

To tune the integral time settings, follow this procedure:

1. Make sure the proportional band is tuned properly.

2. Press the **STOP** key.



3. Press the **PARAM** key until the alpha display shows INTEGRL IS.



INTEGRL IS

4. Enter the recorded setting from Step 1 on Page 37.

a. Press the **EDIT** key.



b. Select the numeric key(s) to show the recorded setting on the numeric display.

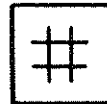

#

c. Press the **ENT** key. The alpha display shows --SAVING-- for one second.



--SAVING--

5. Press the **RUN** key. The alpha display shows PROG/MAN ?.



PROG/MAN ?

6. Press the **MAN** key.



Continued on the next page.

7. Press the **VALUE** key until the alpha display shows SET-PNT 1C.



8. Press the **EDIT** key. A setpoint outside the proportional band and below the process variable is 0.



9. Press the **0** key.



10. Press the **ENT** key. The numeric display shows the new setpoint.

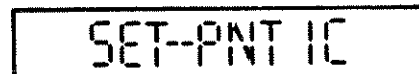

11. Press the **CLR** key. The alpha display shows VARIABL 1C.



a. Watch the numeric display to see if the chamber temperature oscillates near the setpoint.

b. If the chamber temperature oscillates, increase the integral time by 20 seconds.

1. To increase the integral time, follow this procedure:

a. Press the **PARAM** key until the alpha display shows INTEGRL 1S.



b. Press the **EDIT** key. Increase the current value by 20.



c. Press the **ENT** key. The alpha display shows --SAVING--.



Continued on the next page.

c. If the chamber temperature never reaches the setpoint, decrease the integral time by 20 seconds.

1. To decrease the integral time, follow this procedure:

a. Press the **PARAM** key until the alpha display shows INTEGRL 1S.



INTEGRL 1S

b. Press the **EDIT** key. Decrease the current value by 20.



c. Press the **ENT** key. The alpha display shows --SAVING--.



--SAVING--

12. Bring the chamber temperature above the setpoint and repeat Steps 5 through 11 until the chamber reaches setpoint but does not oscillate.

HOW TO CALIBRATE THE 2800

A thermocouple potentiometer is needed to calibrate the 2800. To calibrate the 2800, follow this procedure:

1. Press the **SETUP** key. The alpha display shows SETUP.



--SET UP--

2. Press the **X** key hidden above the letters OGRA between the two displays. The alpha display shows CALIBRATE.

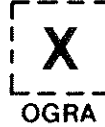

CALIBRATE

CAUTION: To prevent loss of calibration, do not scroll through the calibration procedure unless calibration is needed.

3. If calibration is needed, press the **ENT** key. The alpha display shows INPUT CAL.

OR

If calibration is not needed, press the **CLR** key. The 2800 exits the setup mode.



INPUT CAL

4. If thermocouple calibration is needed, press the **ENT** key again. The alpha display shows ZERO VALUE.

OR

If thermocouple calibration is not needed, press the **CLR** key. Go to Step 11 on Page 45.



ZERO VALUE

##

- Connect a thermocouple potentiometer to Channel 1 (and Channel 2 if required) input terminals on the main board as shown in Figure 5.

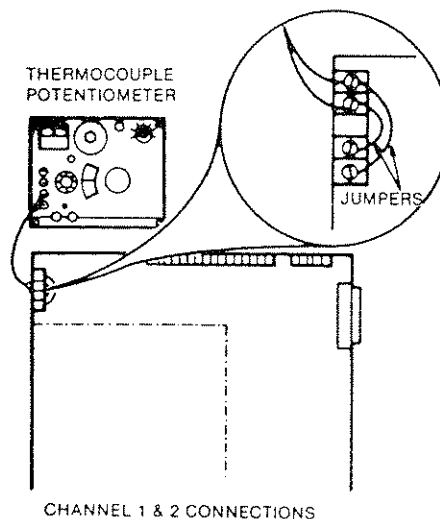
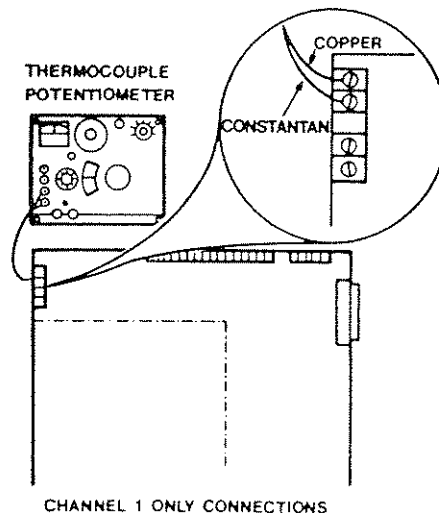
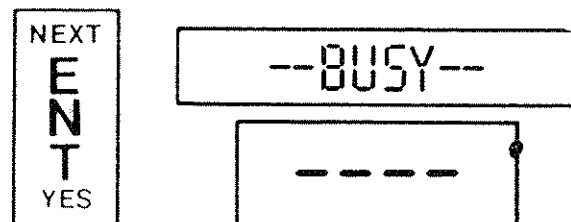

FIGURE 5

- Set the output of the potentiometer to the value shown on the numeric display.
- Press the **ENT** key to start the data input. The alpha display shows -- BUSY -- for 20 seconds. Do not change the setting while the alpha display shows -- BUSY --.



Continued on the next page.

NOTE: If the **STOP** key is pressed during calibration and the numeric display does not contain a value, the 2800 shows OLD VALUES for two seconds and then leaves the setup mode.

8. The alpha display shows SPAN VALUE.
9. Set the output of the potentiometer to the value shown on the numeric display.
10. Press the **ENT** key to start the data input. The alpha display shows -- BUSY -- for 20 seconds. **Do not change the setting while the alpha display shows -- BUSY --.**

SPAN VALUE
###

NEXT
ENT
YES

--BUSY--

OUTPUT CAL

11. The alpha display shows OUTPUT CAL.
- NOTE:** If the 2800 has the multioption board, OUTPUT CAL prompt appears. If the 2800 does not have the multioption board, go to Step 25 on Page 48.

NEXT
ENT
YES

OUT 1 ZERO

12. To exit the setup mode, press the **CLR** key. Go to Step 25 on Page 48. To continue with the calibrations press the **ENT** key.
13. Check the equipment connections to the outputs.
 - a. The temperature output signal has:
 1. a range from -85°C to $+185^{\circ}\text{C}$ (-121°F to $+365^{\circ}\text{F}$).
 2. a linear curve.
 3. a level from 0 to 5 volts.
 - b. The percent relative humidity and linear output signals have:
 1. a range from 0 to 100%.
 2. a level from 0 to 5 volts.

14. If necessary, adjust the voltage using one of the following keys:

- a. The **-** key decreases the output by 0.001 volts.
- b. The **./:** key increases the output by 0.001 volts.
- c. The **9** key decreases the output by 0.012 volts.
- d. The **7** key increases the output by 0.012 volts.

15. When the voltage is correct, press the **ENT** key. The alpha display shows OUT 1 SPAN.

NEXT
ENT
YES

OUT#SPAN

16. Check the equipment connections to the outputs.

- a. The temperature output signal has:
 1. a range from -85°C to $+185^{\circ}\text{C}$ (-121°F to $+365^{\circ}\text{F}$).
 2. a linear curve.
 3. a level from 0 to 5 volts.
- b. The percent relative humidity and linear output signals have:
 1. a range from 0 to 100%.
 2. a level from 0 to 5 volts.

Continued on the next page.

17. If necessary, adjust the voltage using one of the following keys:
 - a. The **-** key decreases the output by 0.001 volts.
 - b. The **./:** key increases the output by 0.001 volts.
 - c. The **9** key decreases the output by 0.012 volts.
 - d. The **7** key increases the output by 0.012 volts.

18. When the voltage is correct, press the **ENT** key. The alpha display shows OUT 2 ZERO.

19. Check the equipment connections to the outputs.
 - a. The temperature output signal has:
 1. a range from -85°C to $+185^{\circ}\text{C}$ (-121°F to $+365^{\circ}\text{F}$).
 2. a linear curve.
 3. a level from 0 to 5 volts.
 - b. The percent relative humidity and linear output signals have:
 1. a range from 0 to 100%.
 2. a level from 0 to 5 volts.

20. If necessary, adjust the voltage using one of the following keys:
 - a. The **-** key decreases the output by 0.001 volts.
 - b. The **./:** key increases the output by 0.001 volts.
 - c. The **9** key decreases the output by 0.012 volts.
 - d. The **7** key increases the output by 0.012 volts.

21. When the voltage is correct, press the **ENT** key. The alpha display shows OUT 2 SPAN.

22. Check the equipment connections to the outputs.

a. The temperature output signal has:

1. a range from -85°C to $+185^{\circ}\text{C}$ (-121°F to $+365^{\circ}\text{F}$).

2. a linear curve.

3. a level from 0 to 5 volts.

b. The percent relative humidity and linear output signals have:

1. a range from 0 to 100%.

2. a level from 0 to 5 volts.

23. If necessary, adjust the voltage using one of the following keys:

a. The **-** key decreases the output by 0.001 volts.

b. The **./:** key increases the output by 0.001 volts.

c. The **9** key decreases the output by 0.012 volts.

d. The **7** key increases the output by 0.012 volts.

24. When the voltage is correct, press the **ENT** key.

25. The alpha display shows OK TO SAVE.

NEXT
**E
N
T**
YES

--SAVING--

OK TO SAVE

Continued on the next page.

26. To save the new calibrations, press the **ENT** key. To use the old values, press the **CLR** key. The 2800 burns (loads) the memory and checks for a proper burn. The alpha display shows -- SAVING --.

NOTE: If the alpha display shows - OPEN T/C - check the input connections. If you have not removed the voltage source, remove the voltage source and connect the inputs.

27. If the burn is bad, the alpha display shows BAD BURN for two seconds. The alpha display then shows TRY AGAIN. Press the **ENT** key to repeat the burn.

NOTE: If the alpha display shows BAD BURN more than twice, contact your local Thermotron field service office.

THE TERMINAL BLOCK CONNECTIONS ON THE MAIN BOARD

⚠ WARNING: To prevent electrical shock, do not touch the transformer and terminal block TB5 on the main board when power is connected.

- TB1 Thermocouple Inputs** See Figure 6.
- 1- Channel 1 thermocouple positive (blue).
 - 2- Channel 1 thermocouple negative (red).
 - 3- No connection--ambient junction compensator.
 - 4- Channel 2 thermocouple negative (red).
 - 5- Channel 2 thermocouple positive (blue).

- TB2 Digital Input/Output** See Figure 6.
- 1- Refrigeration machinery-on output.
 - 2- Alarm output Channel #1 (temperature).
 - 3- Common.
 - 4- Auxiliary output #4.
 - 5- Auxiliary output #3.
 - 6- Auxiliary output #2.
 - 7- Auxiliary output #1.
 - 8- Common.
 - 9- Alarm output Channel 2 (relative humidity).
 - 10- Humidity system-on output.
 - 11- Common.
 - 12- Controller-on status output.
 - 13- Auxiliary cooling output.
 - 14- No connection.
 - 15- No connection.
 - 16- Common.
 - 17- No connection
 - 18- No connection

- TB5 Power Connections** See Figure 6.
- 1- Ground.
 - 2- Neutral.
 - 3- Line 115 Volts AC.

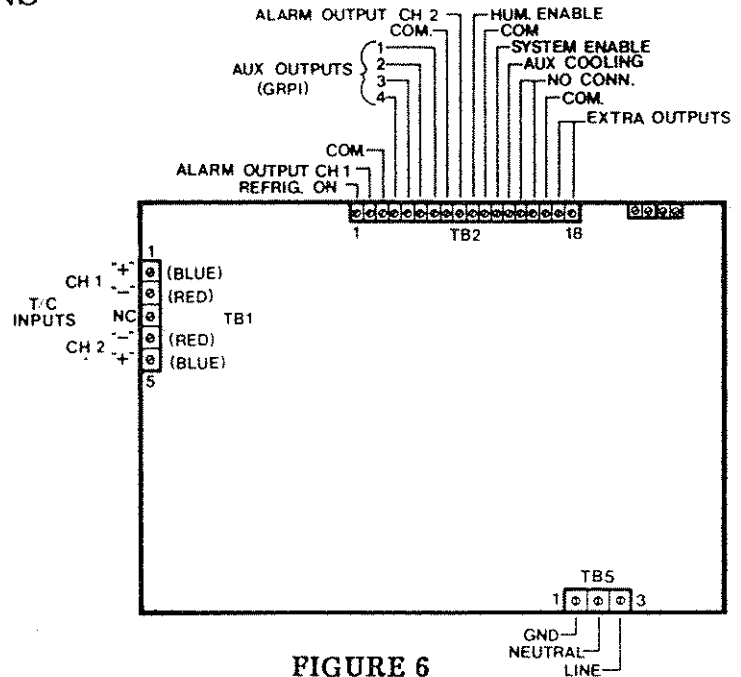

FIGURE 6

THE OPTIONAL FEATURES

THE MULTIOPTION BOARD OPTION

The multioption board is an optional feature on the 2800. The multioption board mounts to the multifunction board of the 2800. The board is connected to the 2800 via a ribbon cable. See Figure 7. The 2800 knows if the multioption board is connected.

The multioption board for the 2800 has the following features:

1. A real-time clock that shows the time in hours and minutes and the date in month and day. The clock provides timing for the data logging, and for the delayed start function.
2. A serial interface (RS-232) that connects a compatible printer to the 2800 for data logging. To be compatible the printer must have the following features:
 - * DTE configuration with a DCE connector
 - * 2400 bits/per second
 - * 8 bits/character
 - * minimum 20 characters line length
3. Two analog outputs that retransmit the following output:
 - * 0 to 5 volt output
 - * -75°F to $+175^{\circ}\text{F}$, linear Channel 1 0 to 100%, relative humidity channel 2.
 - * Software calibration

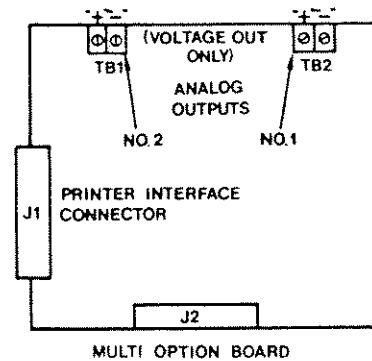

FIGURE 7

HOW TO SET THE TIME AND THE DATE ON THE REAL-TIME CLOCK

When the 2800 is in the stop state, the run manual state, or the hold program state, the real-time can be set.

To set the time, follow this procedure:

1. Press the **TIME** key until the alpha display shows **TIME**.
2. Press the **EDIT** key.
3. Use the numeric keys to select the time.
 - a. Time is shown in military (24 hour) time. Example: 14.15 means 2:15 p.m.
 - b. Use the **./:** key to separate the hours from the minutes.
4. To start the clock, press the **ENT** key. The clock starts at the selected time.



To set the date, follow this procedure:

1. Press the **TIME** key until the alpha display shows **DATE**.
2. Press the **EDIT** key.
3. Use the numeric keys to select the date.
 - a. Use the **./:** key to separate the month from the day.
4. To start the clock, press the **ENT** key. The clock starts at the selected date.



HOW TO PROGRAM THE DELAYED START

The delayed start allows a program to start at a future date and time. To set the delayed start feature, follow this procedure:

1. Press the **STOP** key.



2. Press the **RUN** key. The alpha display on the 2800 shows PROG/MAN ?.



PROG/MAN ?

3. Press the **PROG** key.



PROG NMBR

4. Press the numeric key(s) to select the program number



7

5. Press the **ENT** key. The alpha display shows INTV NMBR.



INTV NMBR

6. Press the numeric key(s) to select the interval number.

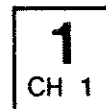

1

7. Press the **ENT** key. The 2800 recognizes that the real-time clock is present. The alpha display shows DLYD START.



DLYD START

8. Press the **ENT** key to select the delayed start function. The alpha display shows **START DATE**.

OR

Press the **CLR** key to cancel the delayed start function. The program starts immediately.

9. The numeric display shows the current date.

- a. If this is the correct start date, press the **ENT** key.
- b. If this is not the correct start date, do the following procedure:
1. Press the numeric key(s) to select the month.

2. Press the **./:** key to separate the month and the day.

3. Press the numeric key(s) to select the day.

4. Press the **ENT** key.

10. The alpha display shows **START TIME**. The numeric display shows the current time.

a. If this is the correct start time, press the **ENT** key.

b. If this is not the correct start time, do the following procedure:

1. Press the numeric key(s) to select the starting hour.

2. Press the **./:** key to separate the hour and the minutes.

3. Press the numeric key(s) to select the starting minutes.

4. Press the **ENT** key.

11. The light emitting diodes in the **STOP**, **RUN**, and **PROG** keys illuminate. At the set time the 2800 starts the selected program and the **STOP** key is no longer illuminated.

NEXT
E
N
T
YES

START DATE

03.01

NEXT
E
N
T
YES

START TIME

NEXT
E
N
T
YES

THE RS-232 SERIAL PRINTER INTERFACE CONNECTIONS

The RS-232 serial interface allows the 2800 to send data to a compatible printer for logging. The parameters of the serial interface are preset for the printer supplied by Thermotron Industries, Inc. These parameters are not changeable.

If your printer allows you to select the required serial configuration, the RS-232 serial interface can be used with other compatible printers

The serial interface configurations for the 2800 printer are:

Connector - DCE connector to conform with most printers
Data Transfer Rate - 2400 bits/second
Word Length 8 bits/character (ASCII characters)
Stop Bits - two stop bits sent
Parity - No parity
Handshake line - RTS or DTR
Handshake Polarity - Active Low busy (BUSY NOT)

The connections made through the printer interface connector are:

1 - Shield
2 - Data input to 2800 (not used)
3 - Data output from 2800
4 - RTS handshake input to 2800 (printers busy signal)
5 - CTS output from 2800 (indicates that 2800 is present)
6 - DSR output from 2800 (indicates that 2800 is present)
7 - Signal common
8-19 - No connection
20 - DTR handshake input to 2800 (printer busy signal)
21-25 - No connection

WHEN DATA GOES TO THE PRINTER

The 2800 sends data to the printer during print intervals and during a change in the alarm status conditions. During print intervals the time is in seconds. The print interval has a range of 0 to 1000 seconds (16 minutes, 40 seconds). For more information, see Pages 31 and 33.

When the print interval has been changed through editing, the data is printed immediately. Data is printed at every print interval thereafter in the program. A print interval time of 0 seconds stops the data print function.

When either channel goes beyond its settings or comes back into its settings, the printer prints to indicate a change in the alarm status.

THE FORMAT OF THE DATA SENT TO THE PRINTER

The 2800 sends data to the printer in the following format:

Column	1	2	3	4	5	6	7	8	9	10	11	12	13	14	15	16	17	18	19	20	
Line 1	M	M	/	D	D		H	H	:	M	M		R	P		0	2	1		T	
Line 2	A		-	0	6	5		-	0	6	5	F		A		9	5		9	5	%

Line 1	Column 1-5	Date
	7-11	Time
	13-14	Status (Run, Stop, Hold, Program, Manual)
	16-18	Interval #
	20	Trigger source (T=time, A=Alarm, I=Computer Interface)

Line 2	Column 1	Channel 1 Alarm Status (A=in alarm)
	2-5	Channel 1 Setpoint
	7-11	Channel 1 Process Variable + Units (F or C)
	14	Channel 2 Alarm Status (A=in alarm)
	15-16	Channel 2 Setpoint
	18-20	Channel 2 Process Variable + Units (%RH)

THE COMPUTER INTERFACE BOARD OPTION

The computer interface board is an optional feature on the 2800. See Figure 8. The 2800 can be connected to a computer by either a GPIB (IEEE-488) board or a RS-232 board. The computer controls the operation of the 2800. The computer also dumps or loads data between the computer and the 2800.

THE COMMANDS

The 2800 accepts three groups of commands from the computer. These groups are Control, Dump, and Load.

All communications are in upper case ASCII.

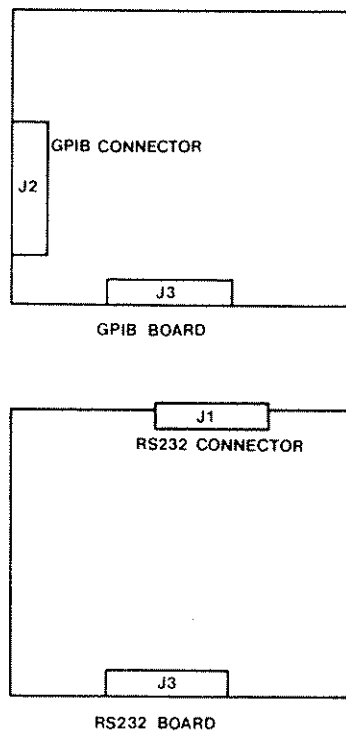

FIGURE 8

THE 2800 COMMAND GUIDE

THE CONTROL GROUP COMMANDS

R Continue a program which was placed in Hold.
RM..... Run in Manual mode from stop -or-
Go to Manual from a program in Hold.
RP Return to a suspended program from Manual.
RPP,i..... Run Program #p at Interval #i from Stop.
S..... Stop Controller and Programmer.
H Hold a Running Program.
I..... Initialize the 2800.
CB Resets the output buffer pointers.
P Triggers the 2800 to print data.

THE DUMP GROUP COMMANDS

DTV..... Dump Temperature Value
DRV..... Dump Relative Humidity Value
DTS..... Dump Temperature Setpoint.
DRS..... Dump Relative Humidity Setpoint.
DPMdd Dump Program from Memory (dd = 1 through 10,).
DPIddd Dump Program Interval (ddd = 0 through 127).
DST..... Dump Status Byte.
DAL..... Dump Alarm Status Byte.
DSR..... Dump Service Request Byte.
DIN Dump Interval Number.
DEC..... Dump Error Code.
DID Dump Identification Command.
D1C..... Dump Channel 1 Unit Character
D2C..... Dump Channel 2 Unit Character
DAX Dump Auxiliaries

THE LOAD GROUP COMMANDS

LTSmddd..... Load Temperature Setpoint (m=sign, ddd=data).
LRSmddd Load Relative Humidity Setpoint (m=sign, ddd=data).
LAXdd..... Load Auxiliary (dd=0 through 15).
LPMdd,iii Load Program Memory at program #p (dd = 0 through 10, iii = 1 through 127).
LPI,ddd,s\$..... Load Program Interval (ddd = 0 through 127, s\$=30 byte string)
LSMddd..... Load SRQ Mask (ddd=decimal value of mask).
LIMddd Load Match Interval (ddd=decimal value of mask).
LKSd..... Load Keyboard Status (d=1 locks keyboard) (d=0 unlocks keyboard).

1

2

3

THE CONTROL GROUP COMMANDS

The control group commands operate the 2800. The following are the control group commands:

EXAMPLES OF THE CONTROL GROUP COMMANDS USING AN HP-85 MICRO-COMPUTER

R	The R or Run command is used with other commands to start the 2800. The R command is used without other commands to continue a program that was placed in hold.	100	OUTPUT 700;"R"
RM	The RM or Run Manual command causes the 2800 to go to the run manual state from the stop or hold program states.	100	OUTPUT 700;"RM"
RP	The RP or Run Program command causes the 2800 to return to the program that was suspended during program operation.	100	OUTPUT 700;"RP"
RPp,i	See the description of the RP command. The lower case pi is not recognized by the 2800. The lower case p represents a variable entry (1-10) for the number of the program to be run. The lower case i is a variable entry for the number of the starting interval.	100	OUTPUT 700;"RP2,1"
S	The S or Stop command stops the 2800 from any running condition.	100	OUTPUT 700;"S"
H	The H or Hold command puts the 2800 in the hold program state.	100	OUTPUT 700;"H"
I	The I or Initialize command forces the 2800 to do a hardware reset. The reset takes three seconds. Do not do any communications while the reset operation is being done.	100	OUTPUT 700;"I"
CB	The CB or Clear output Buffer command resets the output buffer pointers in the 2800. It can become necessary to clear the output buffer when an interrupt occurs during a command.	100	OUTPUT 700;"CB"
P	The P or Print trigger command triggers the 2800 to print data.	100	OUTPUT 700;"P"

THE DUMP GROUP COMMANDS

The dump group commands are used to send specific data to the host computer or to any addressed listener. All dump commands come after the letter D. The following are the dump group commands:

EXAMPLES OF THE DUMP GROUP COMMANDS USING AN HP-85 MICRO-COMPUTER

DTV	The DTV or D ump T emperature V alue command sends the current value of the temperature process variable.	100 110	OUTPUT 700;"DTV" ENTER 700;T
DRV	The DRV or D ump R elative H umidity V alue command sends the current value of the relative humidity value. This is for units with two channels.	100 110	OUTPUT 700;"DRV" ENTER 700;R
DTS	The DTS or D ump T emperature S etpoint command sends the current value of the channel 1 setpoint.	100 110	OUTPUT 700;"DTS" ENTER 700;S1
DRS	The DRS or D ump R elative H umidity S etpoint command sends the current value of the relative humidity setpoint. This is for units with two channels.	100 110	OUTPUT 700;"DRS" ENTER 700;S2
DPMp	The DPM or D ump P rogram M emory command dumps a number of intervals in ASCII decimal and prepares the 2800 to follow DPI commands. The p represents a variable entry (1-10) for the program number to be dumped.	100 110	OUTPUT 700;"DPM" ENTER 700;P\$
DPIi	The DPIi or D ump P rogram I nterval command dumps a 30 byte string that is either the program directory or the program interval. The i represents the directory (0) or the program interval number (1-127).	100 110	OUTPUT 700;"DPI" ENTER 700;B\$
DST	The DST or D ump S tatus command sends the current status byte as a decimal value. See Page 63 for information on the decimal value of the status command.	100 110	OUTPUT 700;"DST" ENTER 700;S

DSR	The DSR or Dump Service Request command sends the value of the service request byte. This command is used with the RS-232 interface option, but can be used with both interfaces. See Page 65 for more information.	100 110	OUTPUT 700;"DSR" ENTER 700;B
DAL	The DAL or Dump ALarm status command sends the current alarm status as a decimal value. See Page 64 for information on the binary value of the alarm status command.	100 110 120	OUTPUT 700;"DAL" ENTER 700;A IF BIT (A,2)...
DIN	The DIN or Dump Interval Number command sends the current interval number.	100 110	OUTPUT 700;"DIN" ENTER 700;I
DEC	The DEC or Dump Error Code finds the reason for an error as noted by bit 5 of the SRQ byte. See Pages 66, 67, and 68.	100 110	OUTPUT 700;"DEC" ENTER 700;E
DID	The DID or Dump IDentification command sends the programmer/controller identity and software version number.	100 110	OUTPUT 700;"DID" ENTER 700;V
D1C	The D1C or Dump channel 1 unit Character command sends the ASCII character representing units of the process variable.	100 110	OUTPUT 700;"D1C" ENTER 700;C1
D2C	The D2C or Dump channel 2 unit Character command sends the ASCII character representing units of the process variable.	100 110	OUTPUT 700;"D2C" ENTER 700;C2
DAX	The DAX or Dump auXiliaries command sends the auxiliary output status.	100 110	OUTPUT 700;"DAX" ENTER 700;XA

THE LOAD GROUP COMMANDS

The load group commands give data to the 2800. All of the load group commands come after the letter L. The following are the load group commands:

EXAMPLES OF THE LOAD GROUP COMMANDS USING AN HP-85 MICRO-COMPUTER

LTS	The LTS or Load Temperature Setpoint command gives temperature setpoint data to the 2800. The 2800 must be in the run manual state and the data must be within the limits of the instrument for this command to be accepted.	100	OUTPUT 700;"LTS-20"
LRS	The LRS or Load Relative Humidity Setpoint command gives relative humidity setpoint data to the 2800.	100	OUTPUT 700;"LRS95"
LAX	The LAX or Load auxiliary allows the auxiliary outputs on the 2800 to be turned on or off. The 2800 must be in the run manual state. The data is sent as a decimal value that represents which auxiliary outputs are on or off.	100	OUTPUT 700;"LAX6"
LPMp,i	The LPM or Load Program Memory command prepares the 2800 to receive a program at a program number. If the program number exists, it will be overwritten by the program being loaded. The i represents the number of intervals to be loaded in the program.	100	OUTPUT 700;"LPM4,9"
LPIi,s\$	The LPI or Load Program Interval loads a 30 byte string. If i = 0, then the 30 byte string is considered to be the program directory. If i = 1 to 127, then the 30 byte string is the program interval.	100	OUTPUT 700;"LPI3","B\$"

LSM	The LSM or Load Srq Mask command activates certain bits in the SRQ byte. The data must be sent as a decimal value that matches an activated mask. A set bit activates its function.	100	OUTPUT 700;"LSM 129"
LIM	The LIM or Load Interval Match commands prepares the match interval to be used by the 2800 if the match interval interrupt is activated.	100	OUTPUT 700;"LIM 3"
LKS	The LKS or Load Keyboard Status command changes the locked status of the keyboard. When the keyboard is locked with the LKS 1 command, the manual unlock function of the 2800 does not work. The LKS 0 command unlocks the keyboard.	100 100	OUTPUT 700;"LKS 1" OUTPUT 700;"LKS 0"

HOW TO DECODE THE STATUS BYTE

To know the status of the 2800, follow this procedure:

1. Convert the decimal value of the status byte to binary.
2. Use the following information to determine the value of the bit position in the status byte:

Bit 7 is set if the keyboard is locked.

Bit 6 is set if the alarm status has changed.

Bit 5 is cleared for the 2800 model.

Bit 4 is set if the units of temperature are in degrees Celsius. Bit 4 is reset if the units of temperature are in degrees Fahrenheit.

Bit 3 is set if the 2800 is in the manual mode with a program suspended.

Bits 2, 1, and 0 indicate the state of the 2800 as follows:

- 000 - Stop
- 001 - Starting
- 010 - Run Manual
- 011 - Run Program
- 100 - Hold Program
- 101 - 2800 being programmed
- 110 - Set up mode
- 111 - Delayed Start mode

STATUS BYTE VALUES

7	-----	Keyboard locked is 1
- 6	-----	Alarm status
-- 5	-----	Model number
--- 4	-----	Degrees C=1 degrees F=0
---- 3	-----	Program suspended is 1
----- 2	-----	} State of 2800
----- 1	-----	
----- 0	-----	

EXAMPLE

146 decimal = 10010010 binary
means

1	The keyboard is locked
0	Not in alarm
0	2800 model
1	The degrees are in Celsius
0	No program is suspended
0	
1	The 2800 is in the Run Manual state
0	

HOW TO DECODE THE ALARM STATUS BYTE

ALARM STATUS BYTE VALUES

To know the alarm status of the 2800, follow this procedure:

1. Convert the decimal value of the alarm status byte to binary.
2. Use the following information to determine the value of the bit:

Bits 7 through 4 are not used (reset to zero.)

Bit 3 is set if Channel 2 process alarm is on.

Bit 2 is set if Channel 2 deviation alarm is on.

Bit 1 is set if Channel 1 process alarm is on.

Bit 0 is set if Channel 1 deviation alarm is on.

NOTE: For a one channel unit, bits 2 and 3 are reset to zero. How the operator sets the alarms determines the process alarm(s) or deviation alarm(s). See Pages 10 through 13, **How to Set the Alarms.**

7	-----	Not used
-6	-----	Not used
--5	-----	Not used
---4	-----	Not used
----3	---	Channel 2 process alarm
-----2	--	Channel 2 deviation alarm
-----1	-	Channel 1 process alarm
-----0		Channel 1 deviation alarm

EXAMPLE

2 decimal = 00000010 binary
means

0	Not used
0	Not used
0	Not used
0	Not used
0	Channel 2 process alarm is off
0	Channel 2 deviation alarm is off
1	Channel 1 process alarm is on
0	Channel 1 deviation alarm is off

HOW TO USE THE SERVICE REQUEST (SRQ) BYTE

THE SRQ BYTE VALUES

To use the service request (SRQ) byte, follow this procedure:

1. When the power is turned on, the SRQ enable mask is automatically 192 decimal (11000000 binary).
2. Use the serial poll DSR command or the GPIB to obtain the SRQ byte.
3. To change a bit in the SRQ mask, use the LSM command.
4. Use the following information to determine the value of the bit:

Bit 7 Power-On Reset - The 2800 executes a power-on reset.

Bit 6 Request for Service - This bit indicates that the 2800 requires service. The remaining bits must be decoded to know what service is required.

Bit 5 Error - The 2800 receives an illegal command or data, or there is an interface error.

Bit 4 End of Program - The program which was running is finished.

Bit 3 Match Interval - the current interval is equal to the interval number loaded with the LIM command. This interrupt occurs when the match interval is first loaded for running by the 2800.

Bit 2 End of Interval - The current interval is completed.

Bit 1 Alarm Change - There has been an alarm change. Note that this does not give alarm status, which must be read using the dump alarm status command. See Page 60.

Bit 0 Data Ready - The data requested from a dump command is ready for transmission.

7	-----	Power-On Reset
- 6	-----	Request for Service
-- 5	-----	Error
--- 4	-----	End of Program
---- 3	-----	Match Interval
----- 2	-----	End of Interval
----- 1	-----	Alarm Change
----- 0	-----	Data Ready

EXAMPLE

224 decimal = 11100000 binary
means

1	Power-on reset occurs
1	This is a request for service
1	There is an error
0	This is not end of program
0	There is no match interval
0	This is not end of interval
0	There has not been an alarm status change
0	No data ready

WHAT THE ERROR CODES MEAN

When the 2800 indicates that an error has occurred, follow this procedure:

1. The DEC command uses the host computer to determine the cause of the error.
2. The host computer receives a code number from the 2800.
3. Use the following information to determine what the code number means:

1- Input buffer overflow.

The 2800 has an input buffer of 10 characters. Only upper case ASCII, numbers, the comma, and the selected terminating character are stored in the input buffer.

2- Not in Stop for Trigger command.

The 2800 received a not-acceptable Group Execute Trigger (GET) command from the GPIB. The 2800 attempts to start running Program #1 at Interval #1. The 2800 must be in the stop state when a GET command is used.

3- Program does not exist for trigger.

This error occurs if the 2800 receives the GET command and there is no Program #1 in memory.

4- GPIB Bus Error.

The GPIB interface driver in the 2800 detects a bus error condition, such as addressed to talk but no active listeners.

5- Serial Input Error.

The Serial interface driver detects an error on input, such as parity, stop bits, framing, etc.

6- Illegal Primary Command.

The 2800 receives a primary command other than R, S, H, I, D, or L.

Continued on the next page.

- 7- Invalid Run Command.
The 2800 receives a not-acceptable run command.
- 8- Invalid Stop Command.
The 2800 receives a not-acceptable stop command.
- 9- Invalid Hold Command.
The 2800 receives a not-acceptable hold command, such as Hold from Run Manual.
- 10- Invalid Secondary Dump Command.
The 2800 receives a not-acceptable secondary command after the dump primary command.
- 11- Invalid Secondary Load Command.
The 2800 receives a not-acceptable secondary command after the load primary command.
- 12- Out of Range Command.
The 2800 receives an out-of-range value after the load secondary command.
- 13- Output Buffer Overflow Command.
The 2800 fills the output buffer. The connected computer must output more characters before the 2800 output buffer can be updated.
- 14- Not in Stop for DPM Command.
The 2800 receives the DPM command while in the Run mode. The 2800 must be in Stop mode when a DPM command is used.
- 15- Program Does Not Exist.
The 2800 receives a DPM command asking for a program number that does not exist.
- 16- Not in Stop for LPM Command.
The 2800 receives the LPM command while in the run state. The 2800 must be in the stop state when an LPM command is used.

- 17- Insufficient Interval Space.
The 2800 receives an LPM command that asks for more 2800 memory than is available. This can be corrected either by decreasing the number of intervals in a program or by deleting other existing programs in the 2800.
- 18- Bad Checksum.
The 2800 receives a program block checksum that does not match the checksum used during a DPM or an LPM command.
- 19- Illegal Configuration Code.
The 2800 receives a program block that does not match the code of the 2800.
- 20- Invalid Program Number.
The 2800 receives an not acceptable program number during a DPM or an LPM command. Only program numbers 1 through 10 can be used.
- 21- Invalid Interval Number.
The 2800 receives an not acceptable interval number during an LPM command. Only interval numbers 1 through 255 can be used.
- 22- Unequal Interval Numbers.
The 2800 receives a number of intervals during an LPI command that did not match the number of intervals stored in the program directory.
- 23- Not in Manual Mode.
The 2800 receives a load command while in an operating mode other then manual.
- 24- Illegal Data Format.
The 2800 receives a number in a load command that is illegal.
- 25- Channel not present.
The 2800 receives a load command addressing a channel that is not present.
- 26- RAM error while in run.
The 2800 receives bad data from RAM during a run command.

THE GPIB INTERFACE BOARD

HOW THE GPIB INTERFACE FUNCTIONS ARE USED BY THE 2800

The GPIB interface option for the 2800 uses functions defined by the IEEE-488 (1978) Standard. To know how the interface functions are used on the 2800, read the following. For more information, see the IEEE-488 guide.

The GPIB uses the interface functions as shown in Figure 18.

1. The **T6** or the Talk function is used in the following way:

When the 2800 is addressed to talk, it sends the data to the last dump command received. If only one variable is of interest, send the dump command once. All future inputs from the 2800 will contain the last available data for that variable.

2. The **SR1** or the Service Request function is used in the following way:

The 2800 responds to a Serial Poll on the GPIB by sending back its SRQ Byte. See Page 65, **How to Use the Service Request (SRQ) Byte**. If your GPIB controller does not support the Service Request Interrupt or Serial Poll functions, use the DSR command to get the SRQ Byte.

3. The **RL1** or the Remote/Local function is used in the following way:

When the 2800 is placed in Remote by the GPIB controller, the keyboard is set to the lock state. Local control may be restored by using the standard unlock sequence for the 2800. If the GPIB controller sends the Local Lock-Out command over the bus, then the standard 2800 unlock feature is not in use.

THE GPIB FUNCTIONS USED BY THE 2800

FUNCTION	DESCRIPTION
SH1	Source Handshake
AH1	Acceptor Handshake
T6	Talker (6)
TE0	Extended Talker*
L4	Listener (4)
LE0	Extender Listener*
SR1	Service Request
RL1	Remote/Local
PP0	Parallel Poll*
DC1	Device Clear
DT1	Group Execute Trigger
C0	Controller*

* = not implemented

FIGURE 18

4. The DC1 or the Device Clear function is used in the following way:

The 2800 forces itself to do a hardware reset upon receipt of the Device Clear command. This function takes approximately 3 seconds to complete. **Do not do any communications while the reset function is being used.** This command has the same function as the I primary command.

One method of waiting for the 2800 to be reset is to trap the Power-on Reset interrupt from the 2800. See Page 65, **How to Use the Service Request (SRQ) Byte.** This indicates that the 2800 has completed the reset function.

5. The DT1 or the Group Execute Trigger function is used in the following way:

The 2800 uses the GET command by running Program #1 at Interval #1. The 2800 must be in the stop state when it receives the GET command and Program #1 must exist. These two conditions must be completed or you will get an error.

HOW TO USE THE GPIB CONFIGURATION SWITCH

The GPIB Configuration switch (SW1) is located on the GPIB interface board. See Figure 9.

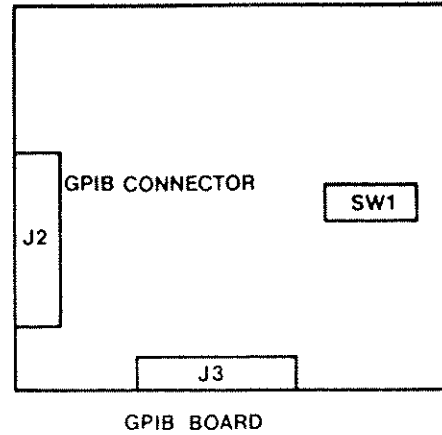

FIGURE 9

The GPIB configuration switch uses the Talk/Listen address on the bus. The GPIB configuration switch is also used to select the line terminating character used by the 2800 for receiving and transmitting data. See Figure 10 for the GPIB configuration switch positions and what the positions mean.

GPIB CONFIGURATION SWITCH POSITIONS AND FUNCTIONS

POSITION	FUNCTION
1	Talk/Listen address*
2	Talk/Listen address*
3	Talk/Listen address*
4	Talk/Listen address*
5	Talk/Listen address*
6	Not used
7	Not used
8	Terminating character selection 0=LF, 1=CR

* Binary code (Sw1=bit 0, etc.)(0 to 30 allowed)

FIGURE 10

The default factory setting for the GPIB configuration switch is (00000000) which means all switches are ON. See Figure 11.

EXAMPLE: Talk/Listen address 14 (decimal),
Line Feed Terminator

Switch	Binary Weight	Position
1	1	0 (on)
2	2	1 (off)
3	4	1 (off)
4	8	1 (off)
5	16	0 (on)
6	x	x (not used)
7	x	x (not used)
8	x	0 (on)

FIGURE 11

WHAT THE GPIB LIGHT EMITTING DIODES MEAN

The GPIB interface board has light emitting diodes used in interface debugging. See Figure 12. The meaning of each of the GPIB light emitting diodes is as follows:

- CTS** Serial Handshake (RS-232 only)
- DSR** Serial Handshake (RS-232 only)
- RDY** Serial Handshake (RS-232 only)
- XMT** Transmit
Data is sent by the 2800. The 2800 is an active talker and provides the Source Handshake function.
- REC** Receive
Data is received by the 2800. The 2800 is an active listener and provides the Acceptor Handshake.
- SRQ** Service Request
The 2800 polls the GPIB SRQ line that indicated service is needed. The bus controller uses a Serial Poll to find the reason for the SRQ.
- LOC** Local
The 2800 is in the Local state.
- REM** Remote
The 2800 is in the Remote state. The keyboard is locked when the 2800 is in the Remote State.
- TLK** Talk
The 2800 is addressed to talk. The 2800 is in the talk state until it is addressed to listen or it receives the Un-Talk command.
- LSN** Listen
The 2800 is addressed to listen. The 2800 remains in the listen state until it is addressed to talk or it receives the Un-Listen command.

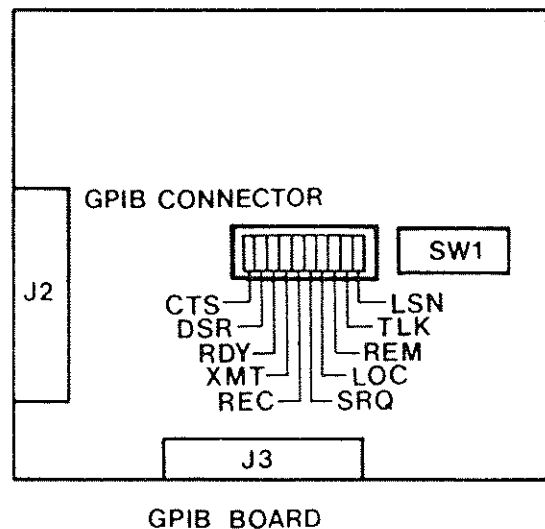

FIGURE 12

THE RS-232 INTERFACE BOARD

HOW TO USE THE RS-232 INTERFACE

The RS-232 serial interface is used as a Data Communications Equipment device (DCE). Different interface parameters are set using the dip switch (SW1). The dip switch is located on the RS-232 computer interface board. See Figure 13.

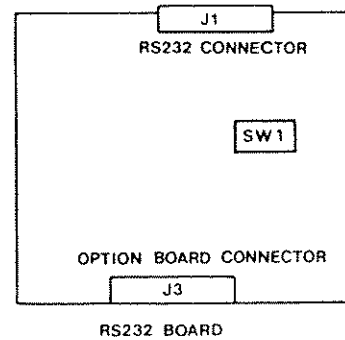

FIGURE 13

The 2800 can be set to communicate with a wide range of serial configurations. Handshaking is available using the RTS/CTS or DTR/DSR lines. Handshaking polarity can be set (Busy or Busy Not). See Figure 14.

RS-232 SWITCH FUNCTIONS

Sw1, Sw2	Data Transfer Rate Selection
0, 0	9600
1, 0	2400
0, 1	1200
1, 1	300
Sw3, Sw4	Parity Selection
0, 0	No parity
1, 0	Odd parity
1, 1	Even parity
Sw5	Handshake Line Selection
0	Use RTS/CTS
1	Use DTR/DSR
Sw6	Handshake Polarity
0	Busy Not
1	Busy
Sw7	Character Word Length Selection
0	8 bits/character
1	7 bits/character
Sw8	Terminator Selector
0	Line feed (ASCII 10)
1	Carriage return (ASCII 13)

FIGURE 14

The factory default setting of the dip switch is 9600 bits per second, no parity, RTS/CTS handshake, active low busy signal, 8 bits/character, line feed terminator. See Figure 15.

DEFAULT SETTING OF THE RS-232 SWITCH

Switch	Position
1	0 (on)(9600 baud)
2	0 (on)
3	0 (on)(no parity)
4	0 (on)
5	0 (on)(RTS/CTS handshake)
6	0 (on)(busy not)
7	0 (on)(8 bits/character)
8	0 (on)(LF terminator)

FIGURE 15

The 2800 uses the connector lines shown in Figure 16.

RS-232 CONNECTOR LINES USED BY THE 2800

WHAT THE RS-232 LIGHT EMITTING DIODES MEAN

The RS-232 interface board has light emitting diodes for use in interface debugging. See Figure 17. The meaning of each of the RS-232 light emitting diodes is as follows:

CTS This light emitting diode shows the status of the input CTS line. When the light illuminates, the CTS line is in the SPACE state (positive).

DSR This light emitting diode shows the status of the input DSR line.

RDY This light emitting diode shows the 2800's handshake output. When the light emitting diode illuminates, the 2800 is ready to receive.

XMT Transmit. Data is sent by the 2800.

REC Receive. Data is received by the 2800.

SRQ Service Request. This light emitting diode shows that the 2800 needs service. Since the RS-232 can not be interrupted, the host computer polls the 2800 using the DSR command to check when the 2800 needs service.

LOC Local. The 2800 is in the local state.

REM Remote. The 2800 is in the Remote state. The keyboard is locked when the 2800 is in the Remote state.

TLK Talk (GPIB only).

LSN Listen (GPIB only).

Line	Function
1	Shield
2	The 2800 receives data on this line
3	The 2800 transmits data on this line
4	RTS-Possible handshake input line (with CTS)
5	CTS-Possible handshake output line (with RTS)
6	DSR-Possible handshake output line (with DTR)
7	Signal Common
8	RLSD-not used
9-19	No Connection
20	DTR-Possible handshake line (with DSR)
21-25	No Connections

FIGURE 16

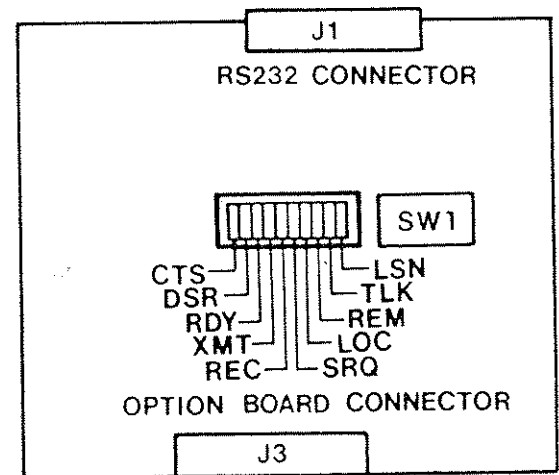

RS232 BOARD

FIGURE 17

THE SAMPLE PROGRAMS

A SAMPLE TEMPERATURE PROGRAM

INIT VAL 1 20°C
(initial value, interval 1, channel 1)

INT (interval) (number)	FVI (final) (value)	INT TIME/CONT DEV (interval) (continue) (time) (deviation)	AUX (auxiliary)	NEXT INT (next) (interval)	LOOPS (# of) (loops)
1	20	00:30	---	2	
2	150	00:30	1---	3	
3	150	02:00	-2--	4	
4	-20	00:30	12--	5	
5	75	00:15	-2--	6	
6	100	00:00 1	-2--	7	
7	50	00:00 1	-2--	8	
8	75	00:00 1	-2--	6/9	5
9	75	00:15	-2--	10	
10	-20	00:30	12--	11	
11	-20	01:45	-2-4	12	
12	100	00:00 1	12--	13	
13	100	01:00	---	14	
14	20	00:00 1	1-3-	1/STOP	100

NOTE: Whenever there is 00:00 time, the CONT DEV prompt appears in the alpha display. In this example, there are five instances where continuous deviation is used. The value of 1 means the next interval starts when the process variable is within one degree of the final value.

Also, note that there are two loops in this program, one being nested inside the other. When the 2800 gets to interval #6, a three stage step function begins. The programmer has been programmed to loop from interval #8 to interval #6 five times. After five loops, the programmer continues to interval #9. Once interval #14 completes, the programmer loops back to interval #1, including the 5 loops between intervals 6 and 8. This larger loop will cycle 100 times. After 100 loops from interval 14 to interval 1, the programmer will stop.

TEMPERATURE PROFILE

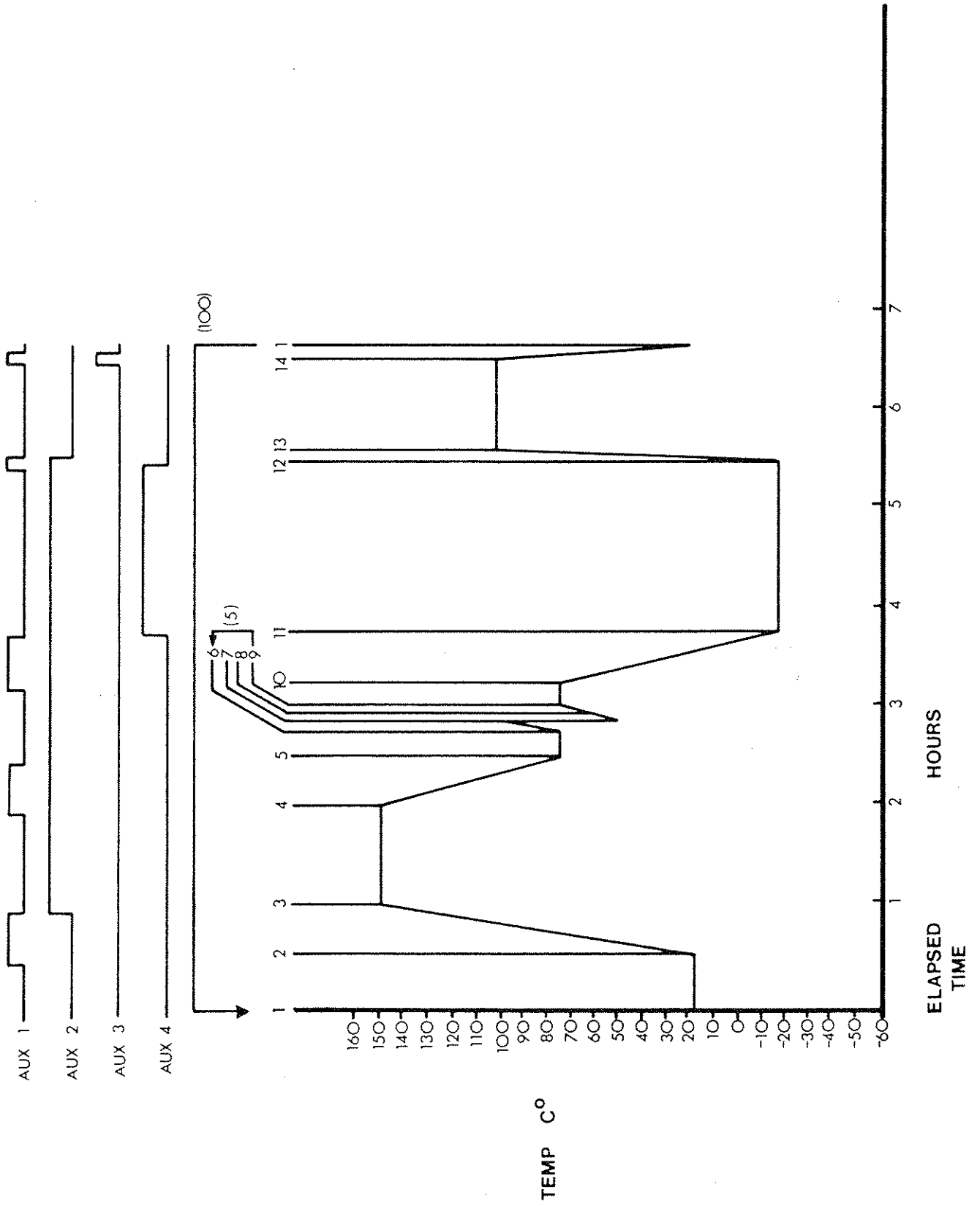

A SAMPLE RELATIVE HUMIDITY PROGRAM

INIT VAL 1 50°C
 (initial value, interval 1, channel 1)

INIT VAL 2 50% relative humidity
 (initial value, interval 1, channel 2)

INT (interval) (number)	FV1 (final) (value)	FV2 (final) (value)	INT TIME /CONT DEV (interval) (continue) (time) (deviation)	AUX (auxiliary)	NEXT INT (next) (interval)	LOOPS (# of) (loops)
1	50	50	00:30	---	2	
2	50	95	01:00	---	3	
3	50	95	01:00	---	4	
4	85	95	00:00	1---	5	
5	85	95	02:00	-2--	6	
6	85	25	01:00	---	7	
7	85	25	00:30	---	8	
8	25	25	00:00	1---	9	
9	25	25	03:30	---	10	
10	15	45	00:30	---	11	
11	15	45	02:00	---	12	
12	5	70	00:30	---	13	
13	5	95	00:30	---	14	
14	5	95	01:00	---	15	
15	50	95	00:00	1---	16	
16	50	95	01:00	---	3	10

NOTE: Whenever there is 00:00 time, the CONT DEV prompt appears in the alpha display. In this example, there are three times when continuous deviation is used. The value of 1 means that the next interval starts when the process variable is within one degree of the final value.

RELATIVE HUMIDITY PROFILE

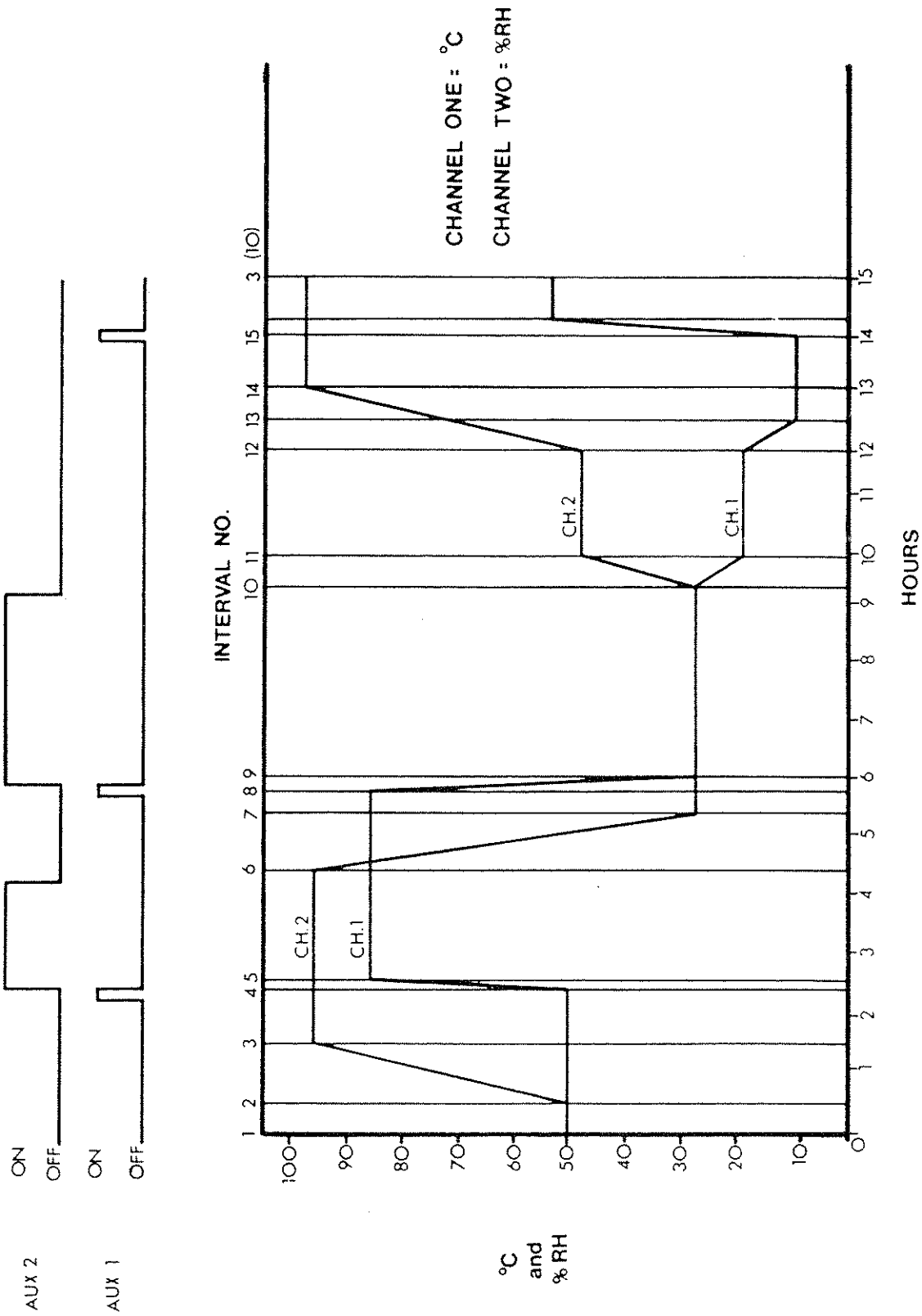

BASIC LANGUAGE SAMPLE PROGRAM NO. 1 USING THE 2800 COMMANDS WITH AN HP-85™ MICRO-COMPUTER AND THE GPIB INTERFACE (PORT 700)

100	CLEAR	Clear the screen
110	LOCAL 7	Disable 2800 keypad lock
120	OUTPUT 700;"RM"	Start 2800 in RUN/MANUAL mode
130	OUTPUT 700;"LTS-20"	Load temperature setpoint of -20 degrees
140	OUTPUT 700;"LAX5"	Turn on AUX 1 & 3 (binary rep. = 0101)
150	OUTPUT 700;"LSM96"	Mask SRQ (enable command/data error bit)
160	A=SPOLL (700)	Dump SRQ byte (SPOLL on GPIB only)
170	IF BIT (A,5) THEN GOTO 350	Check the error bit (if set, error)
180	OUTPUT 700;"DTV"	Dump temperature value
190	ENTER 700;B	Assign temperature value to variable B
200	IF B > -20 THEN GOTO 160	Loop until setpoint achieved
210	DISP "SETPOINT ACHIEVED"	Notify via screen
220	DISP "Press CONT key to continue"	Prompt for PAUSE command
230	PAUSE	Wait for CONT key
240	OUTPUT 700;"LTS100"	Load setpoint of 100 degrees
250	OUTPUT 700;"LAX4"	Turn off AUX 1 (binary rep. = 0100)
260	A=SPOLL (700)	Dump service request byte
270	IF BIT (A,5) THEN GOTO 350	Check the error bit (if set, error)
280	OUTPUT 700;"DTV"	Dump temperature value
290	ENTER 700;B	Assign temperature value to variable B
300	IF B < 100 THEN GOTO 260	Loop until setpoint achieved
310	DISP "SETPOINT ACHIEVED"	Notify via screen
320	DISP "Press CONT key to stop"	Prompt for PAUSE command
330	PAUSE	Wait for CONT key
340	GOTO 380	All done
350	OUTPUT 700;"DEC"	Dump error code byte
360	ENTER 700;C	Assign error code to variable C
370	DISP "ERROR CODE = ";C	Display the error code
380	OUTPUT 700;"S"	Stop 2800
390	DISP "END OF TEST"	Display end of test message
400	STOP	Stop program (HP-85)
410	END	End program (HP-85)

HP-85 = Hewlett Packard
GW-BASIC = Microsoft
IBM-PC = IBM

PROGRAM PROFILE #1

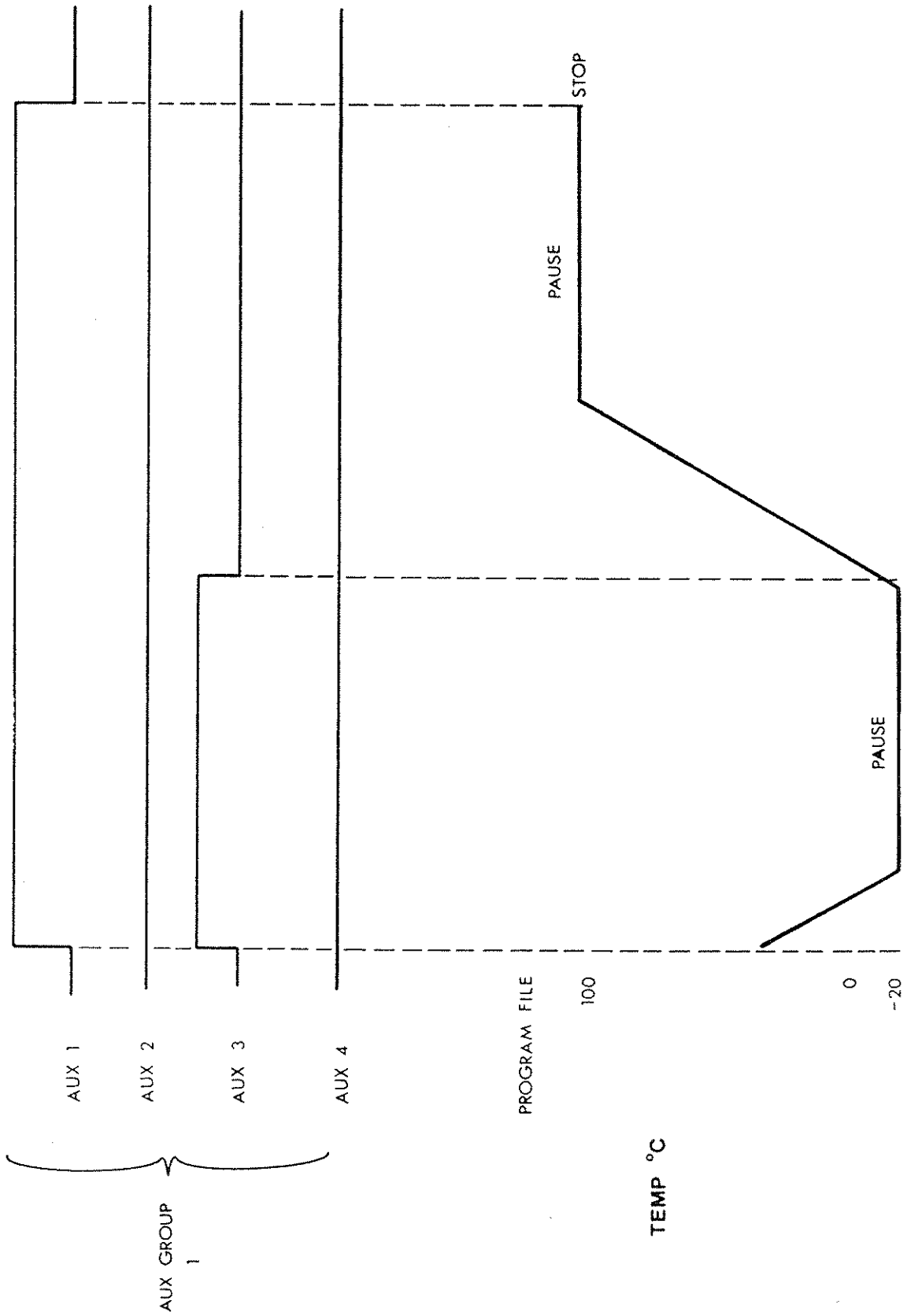

BASIC LANGUAGE SAMPLE PROGRAM NO. 2 USING 2800 COMMANDS WITH AN HP-85™ MICRO-COMPUTER AND THE RS-232 INTERFACE (PORT 10)

Refer to RH PLOT PROGRAM example on Pages 77 and 78 for profile of output. Assume this program is stored in the 2800 as Program No. 2.

100	CLEAR	Clear the screen
120	CONTROL 10,3;15	Configure baud rate at 9600 (HP-85)
140	OUTPUT 10;"I"@ WAIT 3000	Initialize 2800 and wait 3 seconds
150	M\$="TEMP"@ N\$="%RH"@ L\$="INT"	Header assignments
160	S=7 @ P=42	Mask constants
170	DISP USING 600;M\$,N\$,L\$	Display header
180	DISP	Blank line
190	OUTPUT 10;"RP2,1;LIM3;LSM58"	Run program #2, starting at int. #1 Load interval match for interval #3 Load SRQ mask (enable bits 1,3,4,&5)
200	GOSUB 280	Dump variables first time through
210	ON TIMER#1,5000 GOSUB 280	Dump variables every 5 seconds
220	OUTPUT 10;"DSR"@ ENTER 10;A	Dump SRQ byte in variable A
230	IF BIT (A,6) THEN GOTO 340	Is there a request for service?
240	OUTPUT 10;"DST"@ ENTER 10;A	Dump status byte in variable A
250	A=BINAND(A,S)	Mask low three bits
260	IF A<>3 THEN GOTO 490	If not RUN/PROGRAM, notify display
270	GOTO 220	Loop back
280	OUTPUT 10;"CB"	Clear output buffer pointers
290	OUTPUT 10;"DTV;DRV;DIN"	Dump temperature value Dump %RH value Dump Interval Number
300	ENTER 10;T,R,I	T=Temp; R=%RH; I=Interval
310	DISP USING 610;T,R,I	Display variables
320	OUTPUT 10;"CB"	Clear output buffer pointers
330	RETURN	Return from subroutine
340	IF BIT (A,5) THEN GOTO 390	Check Error bit
350	IF BIT (A,4) THEN GOTO 560	Check End of Program bit
360	IF BIT (A,3) THEN GOTO 420	Check Interval Match bit
370	IF BIT (A,1) THEN GOTO 440	Check Alarm bit
380	GOTO 240	Return
390	OUTPUT 10;"DEC"@ ENTER 10;A	Dump Error Code in variable A
400	DISP "ERROR CODE = ";A	Display the Error Code
410	GOTO 520	Stop the Program
420	DISP "NEW LOOP"	Display message for each loop
430	GOTO 240	Return

440	OUTPUT 10;"DAL"@ ENTER 10;A	Dump alarm status in variable A
450	DISP "ALARM STATUS = ";A	Display alarm status
460	B=BINAND (A,P)	Mask Process alarms
470	IF B<>0 THEN GOTO 560	If process alarms, stop program
480	GOTO 240	Otherwise, return
490	DISP "NOT IN RUN/PROGRAM"	Display state change
500	IF A=0 THEN GOTO 560	If in Stop state, stop program
510	GOTO 220	Return
520	OUTPUT 10;"DST"@ ENTER 10;A	Dump Status Byte in variable A
530	A=BINAND (A,S)	Mask low three bits
540	IF A=0 THEN GOTO 560	See if already in Stop mode
550	OUTPUT 10;"S"	Send Stop command
560	OUTPUT 10;"LKS0"	Unlock 2800 keypad
570	DISP "END OF PROGRAM"	Display End message
580	STOP	Stop the program (HP-85)
590	END	Program end (HP-85)
600	IMAGE 4A,3X,3A,3X,3A	Header placement
610	IMAGE MDDD,3X,DDD,3X,DDD	Data placement

BASIC LANGUAGE SAMPLE PROGRAM NO. 3 USING 2800 COMMANDS WITH AN HP-85™ MICRO-COMPUTER AND THE GPIB INTERFACE (PORT 700)

This example stores a 2800 program, such as the relative humidity program on Pages 77 and 78, in the HP-85 computer memory. Assume the program has been stored in the 2800 as Program No. 1.

100	CLEAR	Clear the screen
110	OUTPUT 700;"I"@ WAIT 3000	Initialize the 2800 and wait 3 seconds
120	DISP "DUMP PROGRAM #"	Prompt for program number
130	INPUT G\$	Wait for input (user enters 1)
140	OUTPUT 700;"DPM"&G\$	Dump Program Memory (G\$ = program number)
150	ENTER 700;A	A = ASCII decimal value for No. of intervals
160	DISP "PROGRAM NO. ";G\$	Confirm input
170	DISP "HAS ";A;" INTERVALS"	Confirm output
180	DIM B\$ [31]	Dimension 30 byte array plus terminator (LF)
190	DIM C\$ [500]	Dimension storage $\rightarrow (A*31)+31=465$
200	C\$=""	Clear storage with blanks
210	FOR I=0 TO A	Loop for program directory and each interval
220	OUTPUT 700;"DPI";I	Dump prog. directory first, then each int.
230	ENTER 700;B\$	B\$ = 31 byte string
240	DISP B\$	Confirm transfer
250	C\$=C\$+B\$	Append each string to storage area
260	NEXT I	Next interval
270	DISP "PROGRAM BLOCK"	Title for,
280	DISP C\$	Confirming storage of entire program
290	GOSUB 330	Check for errors (Error Code = 0 \rightarrow OK)
300	OUTPUT 700;"LKS0"	Unlock 2800 keypad
310	STOP	Stop the HP-85
320	END	End of program
330	OUTPUT 700;"DEC"	Dump Error Code
340	ENTER 700;E	E = Error Code
350	DISP "ERROR CODE = ";E	Display the Error Code
360	RETURN	Return from subroutine

BASIC LANGUAGE SAMPLE PROGRAM NO. 4 USING 2800 COMMANDS WITH AN HP-85™ MICRO-COMPUTER AND GPIB INTERFACE (PORT 700)

This example loads a 2800 program from the HP-85 computer memory and stores it in program No. 5 location of the 2800 (If Program No. 5 exists, it will be overwritten). Assume example No. 3 has been run previous to this example. The variables A and C\$ must be available with correct data.

100	CLEAR	Clear the screen
110	OUTPUT 700;"I"@ WAIT 3000	Initialize the 2800 and wait 3 seconds
120	M=1 : N=30	Initialize indices for array
130	DISP "LOAD PROGRAM #"	Prompt for program number
140	INPUT G\$	Wait for input (user enters 5)
150	OUTPUT 700;"LPM"&G\$;" ";A	Load Prog. Mem. (" " = separator A=# int.)
160	DISP "LOAD ";A;"INTERVALS"	Confirm output
170	DISP "INTO PROGRAM NO. "G\$	Confirm input
180	DIM B\$(31)	Dimension 30 byte array plus terminator (LF)
190	FOR I = 0 TO A	Loop for program directory and each interval
200	B\$=C\$(M,N)	Transfer 30 bytes from storage
210	DISP B\$	Confirm transfer
220	OUTPUT 700;"LPI";I;" ";B\$	Load prog. directory first, then each int.
230	M=M+30 : N=N+30	Update indices
240	NEXT I	Next interval
250	GOSUB 290	Check for errors (Error Code = 0 - OK)
260	OUTPUT 700;"LKS0"	Unlock 2800 keypad
270	STOP	Stop the HP-85
280	END	End of program
290	OUTPUT 700;"DEC"	Dump Error Code
300	ENTER 700;E	E = Error Code
310	DISP "ERROR CODE = ";E	Display the Error Code
320	RETURN	Return from subroutine

**GW-BASIC™ LANGUAGE SAMPLE PROGRAM NO. 1 USING THE 2800
COMMANDS WITH AN IBM PC™ MICRO-COMPUTER AND THE RS-232 SERIAL
PORT NO. 1 (COM1:)**

100	COM(1) ON	Enable serial trapping at port #1
110	ON COM(1) GOSUB 470	Trapping routine for characters received
120	OPEN "COM1:9600,n,8,1,cs500 AS #1	Open serial port #1
130	CLS	Clear the screen
140	LF\$=CHR\$(10)	Define the terminator
150	PRINT#1,"LKSO"+LF\$;	Unlock keypad
160	PRINT#1,"RM"+LF\$;	RUN/MANUAL mode
170	PRINT#1,"LTS-20"+LF\$;	Temperature setpoint = -20 degrees
180	PRINT#1,"LAX5"+LF\$;	Turn on AUX 1 & AUX 3
190	PRINT#1,"LSM96"+LF\$;	Mask SRQ
200	PRINT#1,"DSR"+LF\$;	Dump SRQ byte
210	GOSUB 520	Get input
220	A=A AND 32	Mask for error bit
230	IF A<>0 THEN GOTO 410	Test error bit
240	PRINT#1,"DTV"+LF\$;	Dump temperature value
250	GOSUB 520	Get input
260	IF A>-20 THEN GOTO 200	Loop until setpoint achieved
270	PRINT "SETPOINT ACHIEVED"	Display message
280	INPUT "Press RETURN to continue";A	Prompt for input
290	PRINT#1,"LTS100"+LF\$;	Tempnel 1 setpoint = 100 degrees
300	PRINT#1,"LAX4"+LF\$;	Turn off A-UX 1
310	PRINT#1,"DSR"+LF\$;	Dump SRQ byte
320	GOSUB 520	Get input
330	A=A AND 32	Mask for error bit
340	IF A<>0 THEN GOTO 410	Test error bit
350	PRINT#1,"DTV"+LF\$;	Dump channel 1 value
360	GOSUB 520	Get input
370	IF A< 100 THEN GOTO 310	Loop until setpoint achieved
380	PRINT "SETPOINT ACHIEVED"	Display message
390	INPUT "Press RETURN to stop";A	Prompt for input
400	GOTO 440	All done
410	PRINT#1,"DEC"+LF\$;	Dump error code byte
420	GOSUB 520	Get input
430	PRINT "ERROR CODE = ";A	Display error code
440	PRINT#1,"S"+LF\$;	Stop 2800
450	PRINT "END OF TEST"	Display end of test message
460	END	End program (PC)
470	WHILE LOC(1)<>0	While input pointer is not zero
480	PTR=LOC(1)	Input pointer offset

```

490 INBUF$=INBUF$+INPUT$(PTR,#1)
500 WEND
510 RETURN

520 IF RIGHT$(INBUF$,1) <> LF$ THEN
GOTO 520
530 IF ASC(LEFT$(INBUF$,1))>122 THEN
INBUF$=MID$(INBUF$,2,80) : GOTO
530
540 REM If not ASCII character, skip to
next character
550 A=VAL(INBUF$)
560 INBUF$=""
570 RETURN

```

```

Put characters in input buffer
End of while loop
Return from subroutine

```

```

Wait for terminator

```

```

Convert string to numeric value

```

```

Clear input buffer

```

```

Return from subroutine

```

Keep your Thermotron equipment at top efficiency with our preventive maintenance program.

Our environmental simulation equipment and systems are designed to provide many years of dependable service. But for maximum efficiency at all times, each system must be properly maintained and serviced.

Our field service engineers are always on hand to provide emergency service, but with a Preventive Maintenance Agreement, it will seldom be necessary. You'll see:

- Improved operation with the system properly adjusted and calibrated (NBS traceability can be provided).
- Reduced operating costs due to fewer "crisis" situations.
- Increased efficiency with maintenance performed according to your schedule.
- More accurate operating budgets: You'll know your yearly maintenance cost in advance.
- Improved use of funds with less of your money invested in spare parts inventory.
- Simplified administrative procedures — one purchase order keeps the agreement in force for a full year.

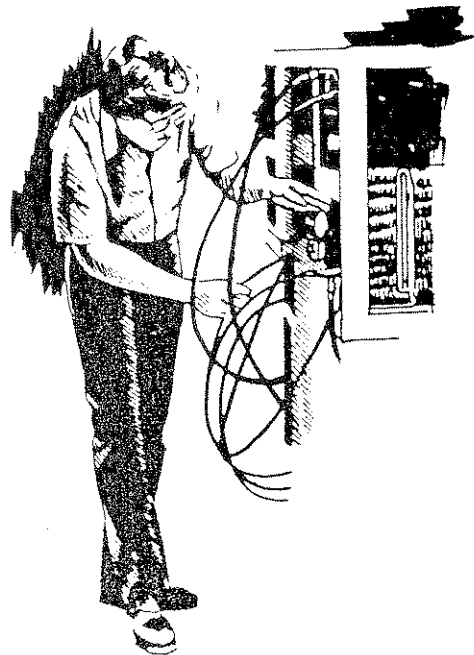

For further information about our Preventive Maintenance Agreement and how it can benefit the

operation of your plant, call us — (616) 392-1491

RESISTANCE TEMPERATURE TABLE FOR PLATINUM RESISTANCE THERMOMETER ELEMENTS

(100 ohms at 0°C/32°F)

Temperature		Resistance of Element (Ohms)*	YSI-Sostman Sensors (metal) Model 4150 Series and Model 4100 Series	
			°C	°F
+340.0	+644	226.18	+340.0	228.51
+320.0	+608	219.13	+320.0	221.32
+300.0	+572	212.03	+300.0	214.09
+280.0	+536	204.88	+280.0	206.81
+260.0	+500	197.70	+260.0	199.49
+240.0	+464	190.46	+240.0	192.12
+220.0	+428	183.17	+220.0	184.70
+200.0	+392	175.84	+200.0	177.23
+180.0	+356	168.47	+180.0	169.72
+160.0	+320	161.04	+160.0	162.16
+140.0	+284	153.57	+140.0	154.55
+120.0	+248	146.06	+120.0	146.90
+100.0	+212	138.50	+100.0	139.20
+80.0	+176	130.89	+80.0	131.45
+60.0	+140	123.24	+60.0	123.66
+40.0	+104	115.54	+40.0	115.82
+20.0	+68	107.79	+20.0	107.93
0.0	+32	100.00	0.0	100.00
-17.8	0	93.01	-19.5	92.67
-28.9	-20	88.61	-40.0	83.99
-40.0	-40	84.21	-60.0	75.90
-51.0	-60	79.81	-62.2	75.01
-62.2	-80	75.39	-67.8	72.74
-73.3	-100	70.95	-73.3	70.48

*For 200 ohm platinum elements, multiply the above resistance values by 2.
For 500 ohm platinum elements, multiply the above resistance values by 5.



THERMOTRON

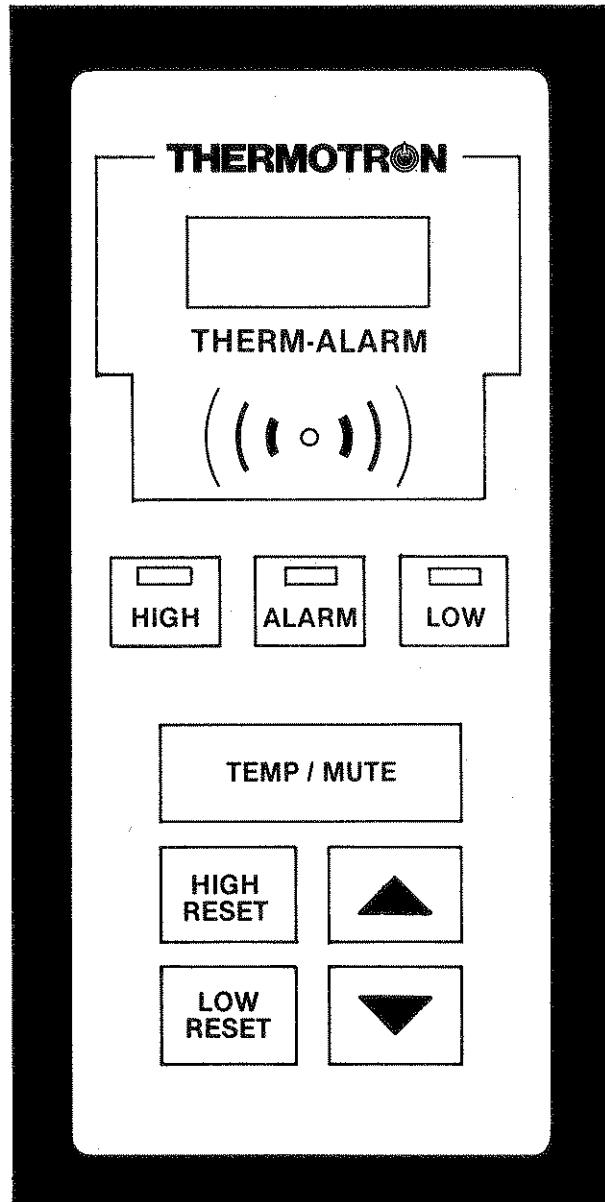

This manual has important information for the safe operation of this instrument. Read this manual carefully and tell all operators to read this manual. If you do not follow the instructions, you can cause an injury or damage to the equipment, the product, and the building.

For new manuals contact:

THERMOTRON INDUSTRIES, 291 Kollen Park Drive, Holland, Michigan 49423 U.S.A.
Phone: (616) 392-1491 TWX 810-292-6164 FAX (616) 392-5643

THERM-ALARM OPERATOR MANUAL









THERM-ALARM
TABLE OF CONTENTS

SAFETY INSTRUCTIONS	1
SPECIFICATIONS	2
INSTRUMENT DESCRIPTION	3
THE OPERATION	4 through 13
THE CONTROLS	4 and 5
The Numeric Display	4
The LED's.....	4
The Tone Generator	4
The Keypad	5
The Rear Panel	5
THE MODES	6, 7 and 8
The Alarm Mode	6
The Warning Mode.....	6
The Scanning Mode	7
The Failure Mode	7
The Open Thermocouple Mode	7
The Limit Temperature Entry Modes.....	8
The Adjustment Mode.....	8
The Calibration Mode.....	8
HOW TO USE THE THERM-ALARM	9, 10 and 11
How to Connect the Outer Wiring	9
How to Position the Input Thermocouple.....	9
How to Show the Input Temperature	9
How to Show the Limit Temperatures	9
How to Enter the Limit Temperatures.....	10
How to Mute an Audible Signal.....	11
How to Reset an Alarm	11
HOW TO ADJUST THE THERM-ALARM	12 and 13
THE CALIBRATION	14
THE REAR PANEL CONNECTIONS	15, 16 and 17
THE TROUBLE-SHOOTING FLOWCHART	18

First Printing.....January, 1987
Second Printing*..... June, 1987
*Pages revised for the second printing are dated 6/87.

SAFETY INSTRUCTIONS

For the safe operation of this instrument, read and follow all warnings and cautions.

-  **WARNING:** If you do not follow the instructions in a **WARNING**, injury can occur to you or to other personnel.
-  **CAUTION:** If you do not follow the instructions in a **CAUTION**, damage can occur to the equipment.
-  **WARNING:** You must have training in the operation of the Therm-Alarm before using it. Read the Instruction Manual.
-  **WARNING:** Do not operate the Therm-Alarm unless it is completely assembled.
-  **WARNING:** To prevent electrical shock, do not touch the terminal blocks TB2, TB4, or the remote transformer. TB4 can be hazardous even when power is removed from TB2.
-  **WARNING:** Always use an electrical supply system with a separate electrical ground conductor. For maximum protection against electric shock, use a circuit that is protected by a ground fault circuit interrupter.
-  **CAUTION:** Maintenance and repairs must be done by authorized personnel only. Make calibrations according to the specifications given in this manual.
-  **CAUTION:** Use a mild soap and water solution to clean the control panel of the Therm-Alarm.
-  **CAUTION:** To prevent electrical damage to the Therm-Alarm, do not connect AC power to terminal blocks TB1, TB3, or TB4.

SPECIFICATIONS

POWER REQUIREMENTS:	117 volts AC $\pm 10\%$, 50/60 hertz, 4 volts-amperes.
TRANSFORMER:	18 volts AC, center-tapped, external
AMBIENT OPERATING TEMPERATURE:	0°C to 50°C (32°F to 122°F)
CHANNELS:	One
TEMPERATURE RANGE:	-87°C to 218°C (-125°F to 425°F), may be limited by application.
INPUT:	Type T Thermocouple
SAMPLING RATE:	Temperature sampled every 0.2 seconds.
MEASURING ACCURACY:	$\pm 1/2^\circ\text{C}$
OUTPUTS:	Visual -- yellow (alarm), green (low limit), and red (high limit) LEDs Audible (2 kilohertz, 90 decibels) -- alarm tone - 0.5 second repeating -- warning tone - 0.1 second repeating -- error tone - 0.5 second -- recognition tone - 0.1 second Contacts -- Double-pole, double-throw mechanical relay contacts rated at 5 amperes at 250 volts AC. SSRs (solid state relays) -- "High Disable," "Low Disable," and "Alarm/Warning" signals are active low. TTL (transistor-transistor logic) -- "Relay Enable" signal is active high, rated at 1 LSTTL or 1 CMOS drive.
PROTECTION:	Open thermocouple protection, internal failure protection.
DIMENSIONS:	Height -- case: 7.4" (18.80 cm) -- bezel: 7.53" (19.13 cm) Width -- case: 3.21" (8.15 cm) -- bezel: 3.785" (9.61 cm) Depth -- behind bezel: 3.27" (8.31 cm) -- overall: 3.64" (9.25 cm), Panel cutout size -- 7.5" (19.0 cm) x 3.4" (8.6 cm)
WEIGHT:	Approximately 3 pounds including external transformer.

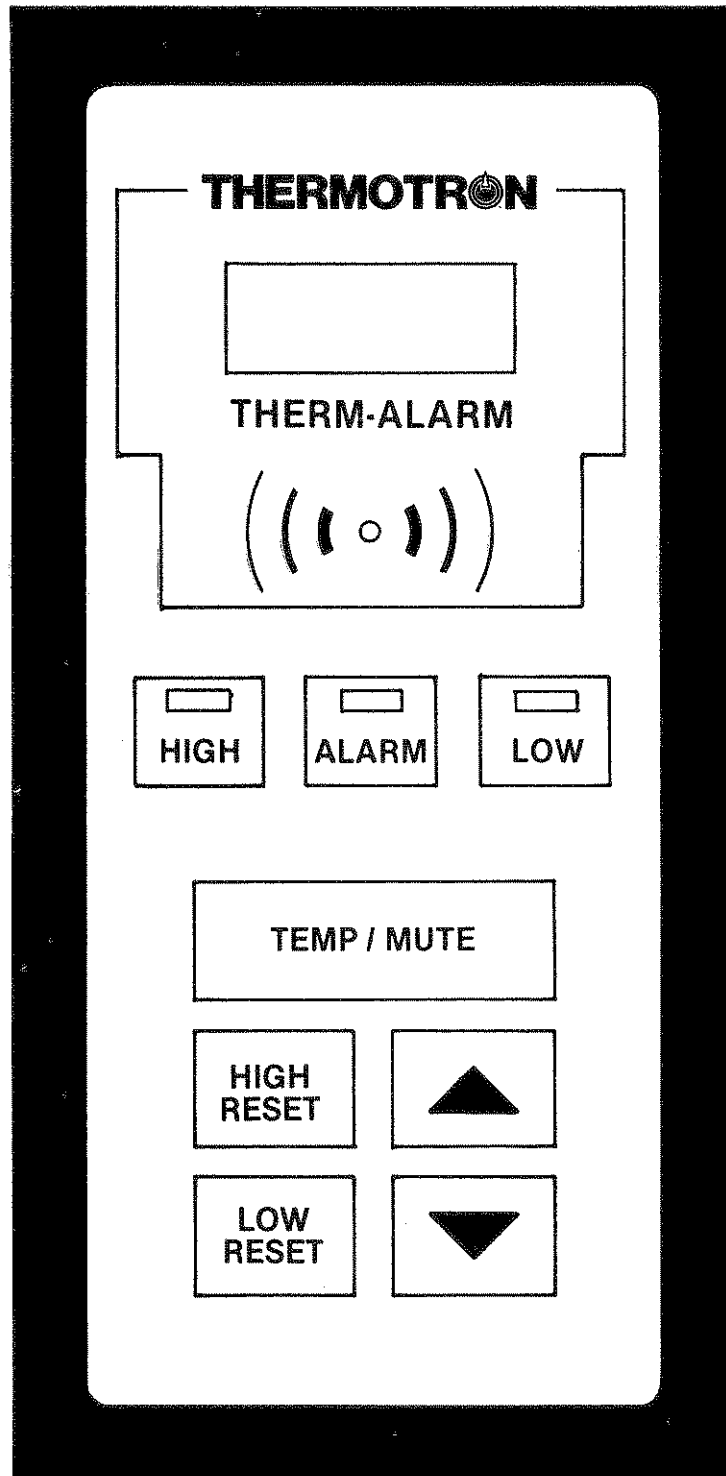

The Therm-Alarm is a high and low temperature alarm and protection system. The Therm-Alarm can detect undesirable temperature conditions in the chamber and alert personnel with audible and visible alarms. The Therm-Alarm can also disconnect power to the product(s) being tested and to the chamber heating and cooling mechanisms.

THE OPERATION

NOTE: In the following instructions, "input temperature" refers to the temperature of the product being tested (measured by the input thermocouple). "Limit temperatures" refer to adjustable high and low temperature settings. If the "input temperature" reaches a "limit temperature," an alarm occurs.

THE CONTROLS

THE NUMERIC DISPLAY — The numeric display is at the top of the control panel. See Figure 1. This four-digit display shows temperatures and other information. Negative temperatures appear with a minus sign (-); positive temperatures appear without a sign. Celsius temperatures appear with a "C"; Fahrenheit temperatures (except -100° and below) appear with an "F".

THE LEDs — The Red LED (above the word "HIGH") indicates a high-temperature condition or setting. The Green LED (above the word "LOW") indicates a low-temperature condition or setting. The Yellow LED (above the word "ALARM") flashes during an alarm. See Figure 1.

THE TONE GENERATOR — The tone generator (below the numeric display) provides audible signals. See Figure 1. It can generate an alarm tone, a warning tone, an error tone (when an incorrect key sequence is used), and a recognition tone (when an acceptable key is pressed).

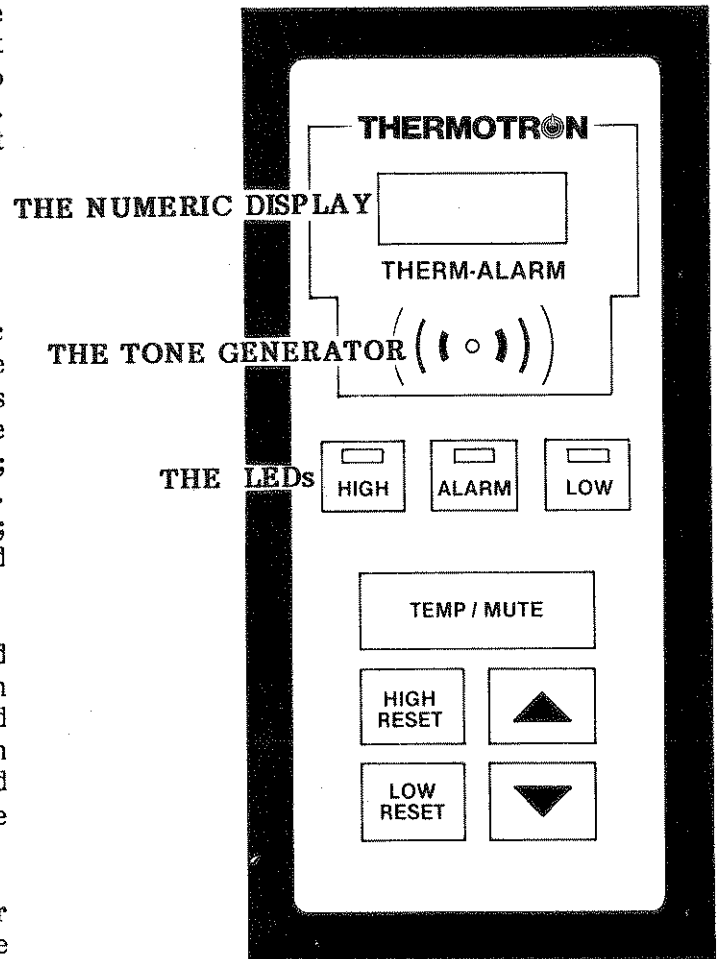

FIGURE 1

THE KEYPAD -- The keypad consists of five keys (See Figure 2). The common uses of the keys are explained below; other specialized uses are explained throughout this manual.

TEMP/MUTE KEY -- This key is used to show the input temperature and to mute an audible alarm.

HIGH RESET KEY -- This key is used to show the high-limit temperature and to manually reset a high-temperature alarm.

LOW RESET KEY -- This key is used to show the low-limit temperature and to manually reset a low-temperature alarm.

UP ARROW KEY -- This key is used to increase certain values shown on the numeric display. Keeping this key pressed causes the value to increase rapidly.

DOWN ARROW KEY -- This key is used to decrease certain values shown on the numeric display. Keeping this key pressed causes the value to decrease rapidly.

THE REAR PANEL -- The rear panel has four terminal blocks for connecting the power supply, the input thermocouple wire, the mechanical contacts, and the SSR and TTL outputs. See **The Rear Panel Connections**, Page 15.

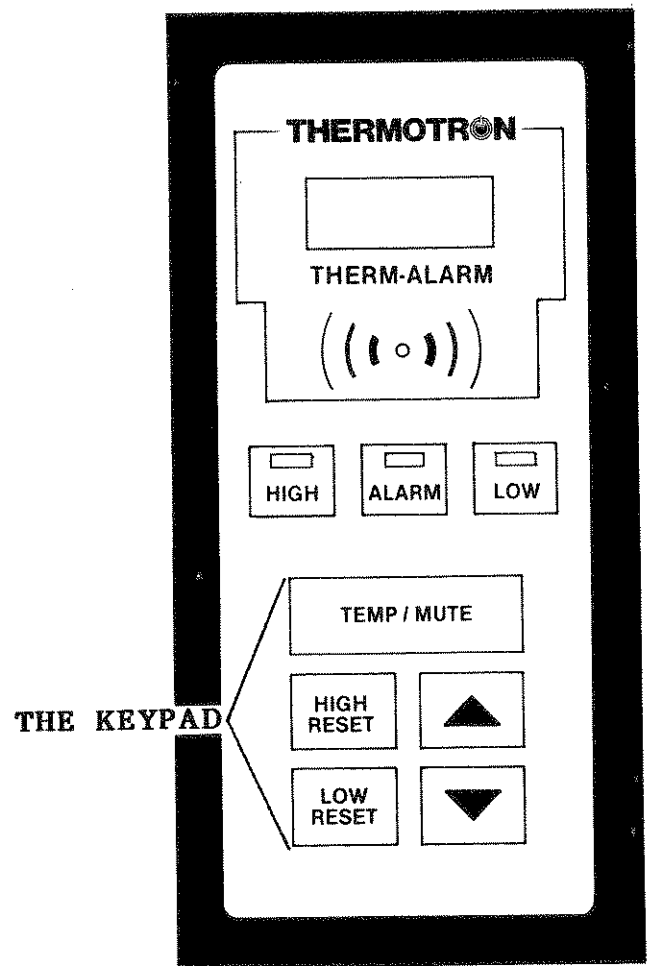

FIGURE 2

THE MODES

THE ALARM MODE -- This mode occurs immediately when the input temperature exceeds a limit temperature by more than five degrees. This mode also occurs after a "nuisance delay" when the limit temperature is exceeded by not more than five degrees. (The nuisance delay time is adjustable -- see **How to Adjust the Therm-Alarm**, Page 12.) During the ALARM mode, the Therm-Alarm disconnects power to protect the chamber and the product(s) being tested. The ALARM mode consists of the following events:

1. The alarm tone is given.
2. The Yellow LED flashes.
3. During a high-temperature alarm, the Red LED illuminates. During a low-temperature alarm, the Green LED illuminates.
4. The most extreme input temperature to occur flashes in the numeric display.
5. The mechanical relay is de-energized.
6. The TTL output goes low.
7. The "Alarm/Warning" SSR output goes low.
8. During a high-temperature alarm, the "High Disable" SSR output goes low. During a low-temperature alarm, the "Low Disable" SSR output goes low.

NOTE: For more information on the mechanical relay, TTL, and SSR outputs, see **The Specifications**, Page 2 and **The Rear Panel Connections**, Page 15.

THE WARNING MODE - This mode occurs when the input temperature comes near a limit temperature. See Figure 3. (The "warning band width" is adjustable -- see **How To Adjust The Therm-Alarm**, Page 12.) The chamber heating and cooling systems continue to operate during the WARNING mode. The WARNING mode consists of the following events:

1. The warning tone is given.
2. During a high-temperature warning, the Red LED flashes. During a low-temperature warning, the Green LED flashes.
3. The numeric display shows the limit temperature that the input temperature is near.
4. The "Alarm/Warning" SSR output goes low.

High-limit temperature: 130°C

Low-limit temperature: 0°C

Warning band width: 15°

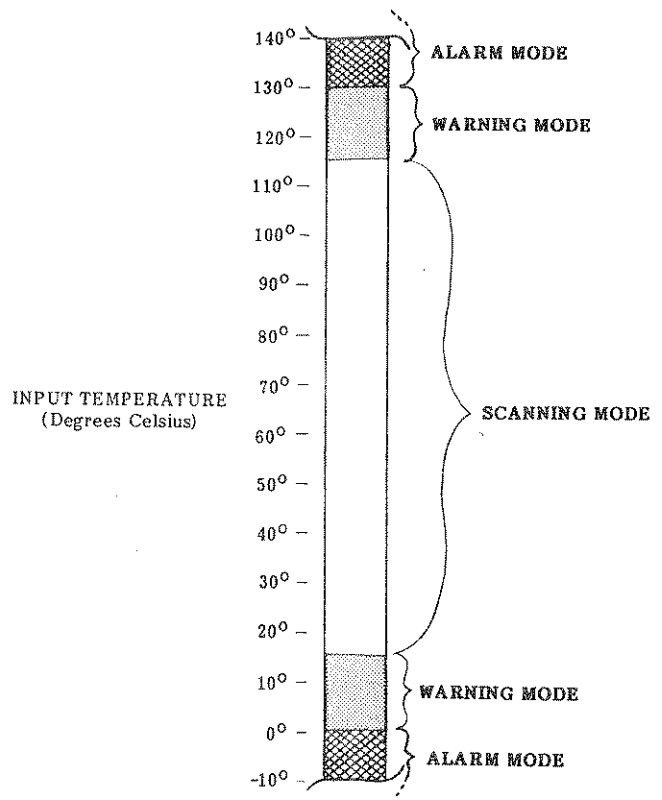

FIGURE 3

THE SCANNING MODE -- This mode occurs during normal operation. The Therm-Alarm stays in the SCANNING mode while the input temperature is in the acceptable range between the high and low warning temperatures. See Figure 3. During this mode, a single or double dash moves across the numeric display; a double dash means that the limit temperatures are set at the highest and lowest allowed values.

THE FAILURE MODE -- This mode occurs if the Therm-Alarm detects a problem with the critical circuits in itself. The Therm-Alarm disconnects power during the FAILURE mode to protect the chamber and the product(s) being tested. The FAILURE mode consists of the following events:

1. The alarm tone is given.
2. The LEDs flash.
3. "FAIL" appears in the numeric display. See Figure 4.
4. The mechanical relay is de-energized.
5. The TTL output goes low.
6. The SSR outputs go low.
7. Only the TEMP/MUTE key operates (to mute the tone).

THE OPEN THERMOCOUPLE MODE -- This mode occurs when the input thermocouple is not connected. The Therm-Alarm disconnects power during this mode to protect the chamber and the products being tested. The OPEN THERMOCOUPLE mode consists of the following events:

1. The alarm tone is given.
2. "OPEN" appears in the numeric display. See Figure 5.
3. The mechanical relay is de-energized.
4. The TTL output goes low.
5. The SSR outputs go low.

Continued on the next page.



FAILURE MODE

FIGURE 4



OPEN THERMOCOUPLE MODE

FIGURE 5

THE LIMIT TEMPERATURE ENTRY MODES --

These modes are used to change the limit temperatures. See **How to Enter the Limit Temperatures**, Page 10.

THE ADJUSTMENT MODE -- This mode is used to change certain features of the Therm-Alarm. See **How to Adjust the Therm-Alarm**, Page 12.

THE CALIBRATION MODE -- This mode is used to calibrate the input temperature measurement. See **The Calibration**, Page 14.

HOW TO USE THE THERM-ALARM

HOW TO CONNECT THE OUTER WIRING --

Use the information provided in **The Rear Panel Connections** , Page 15, to make the necessary wiring connections. Wiring procedures vary according to application.

HOW TO POSITION THE INPUT THERMOCOUPLE --

The thermocouple provides the input temperature and is attached to the Therm-Alarm by a long wire. Since it is important to measure the temperature of the product itself, the thermocouple must be placed directly on the product being tested or as near to the product as possible.

HOW TO SHOW THE INPUT TEMPERATURE --

The input temperature is shown by pressing the TEMP/MUTE key while the Therm-Alarm is in the SCANNING mode, ALARM mode, or WARNING mode. Any repeating tone must be muted before the input temperature is shown. See **How to Mute an Audible Signal**, Page 11.

HOW TO SHOW THE LIMIT TEMPERATURES --

Press the HIGH RESET key to show the high-limit temperature; press the LOW RESET key to show the low-limit temperature. The limit temperatures can be shown during the SCANNING mode, ALARM mode, or WARNING mode.

Continued on the next page.

HOW TO ENTER THE LIMIT TEMPERATURES

NOTE: Read all the necessary steps before entering a LIMIT TEMPERATURE ENTRY MODE. If no keys are pressed for 15 seconds, or if a wrong key is pressed, the Therm-Alarm gives an error tone, exits from the LIMIT TEMPERATURE ENTRY MODE, and uses the previous limit temperature.

To enter the **high-limit** temperature, follow this procedure:

1. Press and hold both the TEMP/MUTE key and the HIGH RESET key together. The numeric display becomes blank. Hold the keys approximately 10 seconds, until a recognition tone is given. The Therm-Alarm is now in the HIGH-LIMIT TEMPERATURE ENTRY mode.
2. Use the arrow keys to select the high-limit temperature.
3. To enter the selected high-limit temperature, again press both the TEMP/MUTE key and the HIGH RESET key together; the Therm-Alarm gives a recognition tone, exits from the HIGH-LIMIT TEMPERATURE ENTRY mode, and uses the new high-limit temperature.



To enter the **low-limit** temperature, follow this procedure:

1. Press and hold both the TEMP/MUTE key and the LOW RESET key together. The numeric display becomes blank. Hold the keys approximately 10 seconds, until a recognition tone is given. The Therm-Alarm is now in the LOW-LIMIT TEMPERATURE ENTRY mode.
2. Use the arrow keys to select the low-limit temperature.
3. To enter the selected low-limit temperature, again press both the TEMP/MUTE key and the LOW RESET key together; the Therm-Alarm gives a recognition tone, exits from the LOW-LIMIT TEMPERATURE ENTRY mode, and uses the new low-limit temperature.

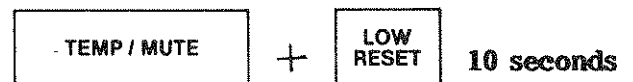

HOW TO MUTE AN AUDIBLE SIGNAL -- Press the TEMP/MUTE key to mute any repeating tone. The amount of time that the tone remains mute is adjustable. See **How to Adjust the Therm-Alarm**, Page 12.

HOW TO RESET AN ALARM -- If the input temperature causes an alarm and then returns to an acceptable temperature, the Therm-Alarm must be reset to exit from the ALARM mode. Either **manual** reset or **automatic** reset can be selected. See **How to Adjust the Therm-Alarm**, Page 12.

If **manual** reset is selected, press the HIGH RESET key to reset a high temperature alarm; press the LOW RESET key to reset a low temperature alarm.

If **automatic** reset is selected, the Therm-Alarm resets itself after the input temperature is two degrees from the limit temperature, within the acceptable range.

The WARNING mode and the OPEN THERMOCOUPLE mode are automatically reset when the condition that caused them is removed. The power must be disconnected from the Therm-Alarm to reset the FAILURE mode.

HOW TO ADJUST THE THERM-ALARM

The following features can be adjusted. The Therm-Alarm is shipped with the settings shown in parentheses:

Temperature Scale, Fahrenheit/Celsius	(Celsius)
Key tone, on/off	(on)
Mute Time Limit	(15 minutes)
Warning Band Width	(5°)
Nuisance Delay Time	(20 seconds)
Reset, automatic/manual	(manual)
Numeric Display Brightness	(12)

To adjust the Therm-Alarm, follow this procedure:

NOTE: Read steps 1 through 4 before entering the ADJUSTMENT MODE. If no keys are pressed for one minute, or if a wrong key is pressed, the Therm-Alarm gives an error tone, exits from the ADJUSTMENT MODE, and uses the previous settings.

1. Press and hold both the HIGH RESET key and the LOW RESET key together. The numeric display becomes blank. Hold the keys approximately 30 seconds, until a recognition tone is given. The Therm-Alarm is now in the ADJUSTMENT mode.



2. Select the feature to be adjusted. The category number on the left-hand side of the numeric display can be increased by pressing the TEMP/MUTE key. The category numbers indicate the following features:

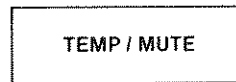

(0): Temperature Scale: "F" (Fahrenheit) or "C" (Celsius) can be selected. If this setting is changed, all the stored temperatures are converted to the selected scale.

(1): Key Tone: "y" (on) or "n" (off) can be selected. If "y" is selected, the Therm-Alarm gives a recognition tone for any valid key press. The "n" setting stops this tone. Other audible signals are not affected by this adjustment.

- (2): Mute Time Limit: 0 to 99 minutes can be selected. This adjustment determines the length of time an audible signal remains silent after it is muted. If "0" is selected, the tone remains mute indefinitely.
- (3): Warning Band Width: 0° to 15° can be selected. This adjustment determines the number of degrees from the limit temperature at which the WARNING mode begins. If 0° is selected, the WARNING mode does not occur.
- (4): Nuisance Alarm Timer: 0 to 30 seconds can be selected. This setting determines the number of seconds that the ALARM mode is delayed after the input temperature reaches a limit temperature. If 0 is selected, the ALARM mode begins immediately when a limit temperature is reached. If the limit temperature is exceeded by more than five degrees, the nuisance delay does not occur.
- (5): Reset: "y" (automatic) or "n" (manual) can be selected. If manual reset is selected, the Therm-Alarm does not exit from the ALARM mode until a reset button is pressed. If automatic reset is selected, the Therm-Alarm resets itself.
- (6): Numeric Display Brightness: 1 (dimpest) to 15 (brightest) can be selected. This setting determines the brightness of the numeric display.

3. Use the arrow keys to increase or decrease the setting. ("F" is above "C" ; "y" is above "n".)
4. When the correct setting is shown, the setting can be entered by again pressing both the HIGH RESET key and the LOW RESET key together. When the setting is entered, the Therm-Alarm gives a recognition tone, exits from the ADJUSTMENT mode and uses the new setting.



+

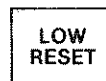

THE CALIBRATION

Calibrate the input temperature measurement of the Therm-Alarm every six months. To calibrate the Therm-Alarm, follow this procedure:

NOTE: If any wrong two-key combination is pressed during the calibration, the Therm-Alarm exits from the CALIBRATION mode and uses the previous values.

1. Press and hold both of the arrow keys together. The numeric display becomes blank. Hold the keys approximately 30 seconds, until a recognition tone is given. The Therm-Alarm is now in the CALIBRATION mode and the Green LED is illuminated.
2. Disconnect the thermocouple. Connect a -87.2°C (-125.0°F) thermocouple reference to the thermocouple input terminals (TB1). See **The Rear Panel Connections**, Page 15.
3. Wait until the calibration value in the numeric display stabilizes. The number must be between 146 and 242.
4. After the number has stabilized, press the TEMP/MUTE key. The Red LED is now illuminated.
5. Connect a 218.3°C (425.0°F) thermocouple reference to the thermocouple input terminals.
6. Wait until the calibration value in the numeric display stabilizes. The number must be between 1250 and 1689.
7. After the number has stabilized, again press both of the arrow keys together to enter the values. If the difference between the calibration values is at least 1000, the Therm-Alarm gives a recognition tone and uses the new values. If the difference between the calibration values is less than 1000, the Therm-Alarm gives an error tone and uses the previous values.
8. Reconnect the thermocouple.



THE REAR PANEL CONNECTIONS

The rear panel has four terminal blocks. See Figure 6. All of the outer wiring of the Therm-Alarm connects to these terminal blocks. Use the following information to connect the outer wiring. Wiring varies according to application.

⚠ WARNING: You must understand electrical work to make the wiring connections.

The four terminal blocks are used as follows:

TB1: Terminal block one is used to connect the input thermocouple wire. The three terminals (numbered left to right) are used as follows:

- #1- This is the positive (+) thermocouple input. Connect the copper thermocouple wire (coded with blue insulation).
- #2- This is the negative (-) thermocouple input. Connect the constant thermocouple wire (coded with red insulation).
- #3- This is the earth ground connection. If shielded thermocouple wire is used, connect the shield to this terminal.

TB2: Terminal block two is used to connect the power supply for the Therm-Alarm. The power supply is an 18 volt AC, center-tapped, external transformer. The four terminals (numbered top to bottom) are used as follows:

- #1- Connect the AC supply from one side of the transformer.
- #2- Connect the center tap of the transformer.
- #3- Connect the AC supply from the side of the transformer not connected to terminal #1.
- #4- This is the earth ground connection. If shielded wire is used on TB2, connect the shield to this terminal.

Continued on the next page.

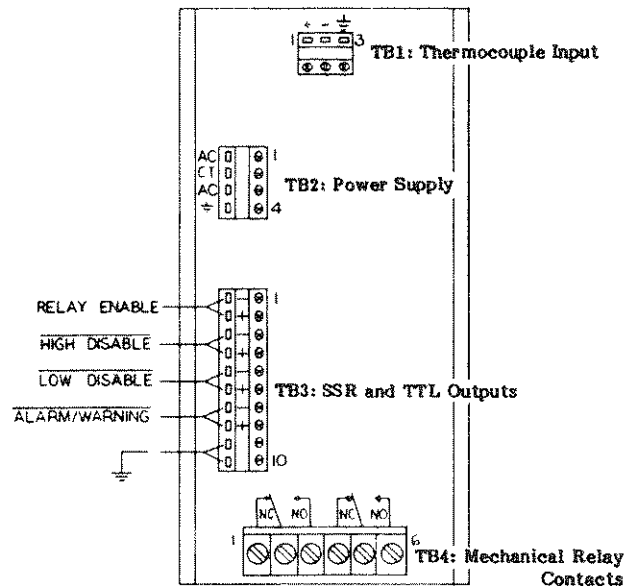

FIGURE 6

TB3: Terminal block three has the connections for the SSR and TTL outputs. These optically isolated outputs are used to indicate the status of the Therm-Alarm. See **The Modes**, Page 6. The ten terminals (numbered top to bottom) are used as follows:

#1- This is the negative (-) connection for the "Relay Enable" TTL output.

#2- This is the positive (+) connection for the "Relay Enable" TTL output.

The "**Relay Enable**" signal is low when the mechanical relay is de-energized (such as during an alarm). It is high during normal operation. This output can drive a 1 LSTTL or 1 CMOS gate. For more information on the mechanical relay, see Page 17.

#3- This is the negative (-) connection for the "High Disable" SSR output.

#4- This is the positive (+) connection for the "High Disable" SSR output.

The "**High Disable**" signal is low during a high-temperature alarm. It is high during normal operation, providing 18 volts DC at up to 20 milliamperes. This output can drive a mechanical or solid-state relay.

#5- This is the negative (-) connection for the "Low Disable" SSR output.

#6- This is the positive (+) connection for the "Low Disable" SSR output.

The "**Low Disable**" signal is low during a low-temperature alarm. It is high during normal operation, providing 18 volts DC at up to 20 milliamperes. This output can drive a mechanical or solid-state relay.

#7- This is the negative (-) connection for the "Alarm/Warning" SSR output.

#8- This is the positive (+) connection for the "Alarm/Warning" SSR output.

The "**Alarm/Warning**" signal is low when the Therm-Alarm is in the ALARM or WARNING mode. It is high during normal operation, providing 18 volts DC at up to 20 milliamperes. This output can drive a mechanical or solid-state relay.

#9 & #10- These are the earth ground connections. Connect the shield of any shielded wire used on TB3.

TB4: Terminal block four has the connections for the mechanical relay contacts. This double-pole, double-throw relay is activated by the modes of the Therm-Alarm. See **The Modes**, Page 6. The three left terminals are for "switch A," the three right terminals are for "switch B." Each switch is rated at 5 amperes at 250 volts AC. Typically, one switch is connected to the chamber power and the other is for customer use. The six terminals (numbered left to right) are used as follows:

 **WARNING:** TB4 can have power applied to it even when power is removed from TB2.

- #1- This is the normally closed contact of switch A. When the mechanical relay is de-energized (such as during an alarm), this contact is closed to the common contact. When the mechanical relay is energized (during normal operation) this contact is open.
- #2- This terminal is the common contact of switch A.
- #3- This is the normally open contact of switch A. When the mechanical relay is de-energized (such as during an alarm), this contact is open. When the mechanical relay is energized (during normal operation) this contact is closed to the common contact.
- #4- This is the normally closed contact of switch B. When the mechanical relay is de-energized (such as during an alarm), this contact is closed to the common contact. When the mechanical relay is energized (during normal operation) this contact is open.
- #5- This terminal is the common contact of switch B
- #6- This is the normally open contact of switch B. When the mechanical relay is de-energized (such as during an alarm), this contact is open. When the mechanical relay is energized (during normal operation) this contact is closed to the common contact.

THERM-ALARM TROUBLE-SHOOTING FLOWCHART

Symptom: Therm-Alarm is not operating.

Note: All voltages referenced to system ground--TB2 pin 3

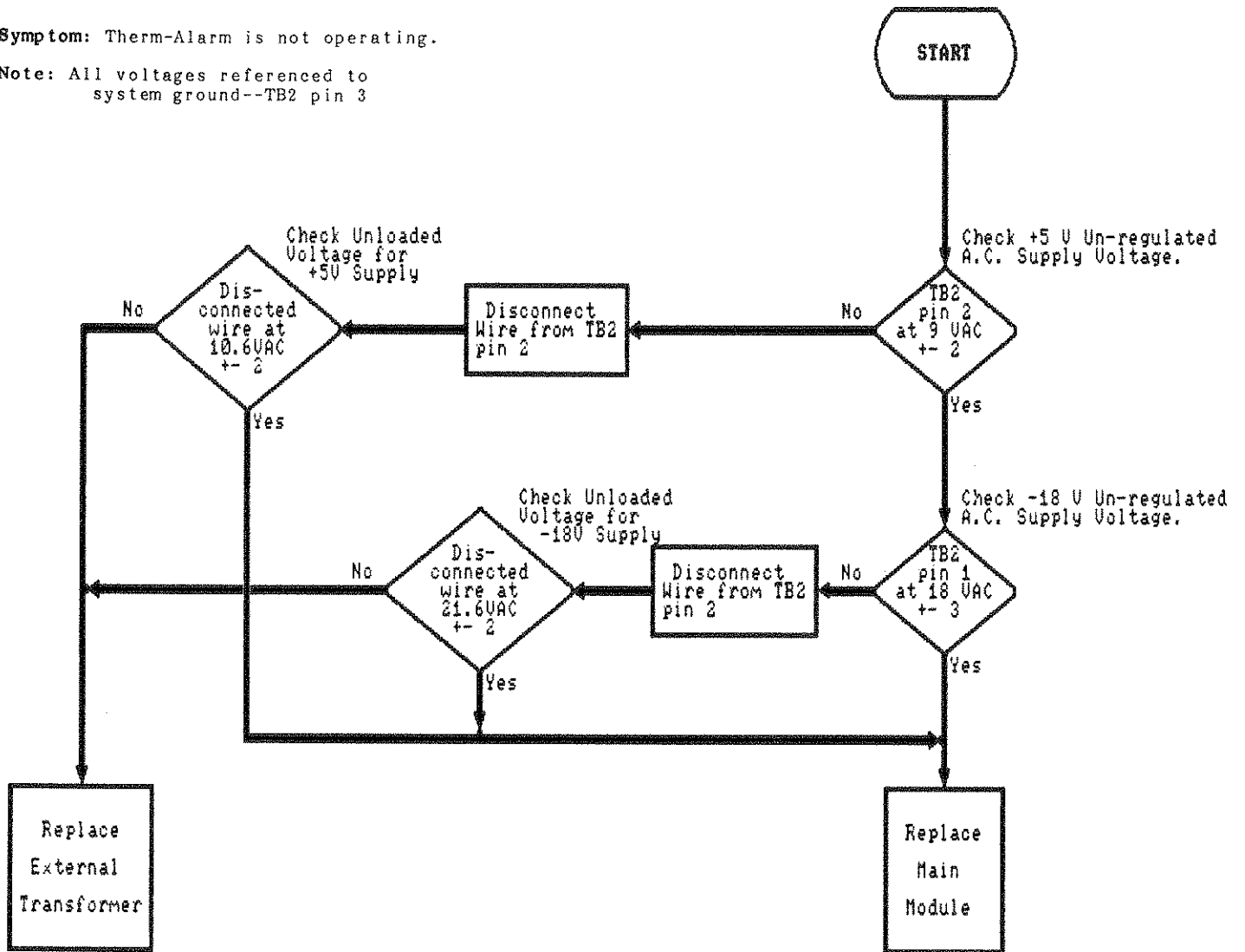

THIS PAGE WAS INTENTIONALLY LEFT BLANK

Keep your Thermotron equipment at top efficiency with our preventive maintenance program.

Our environmental simulation equipment and systems are designed to provide many years of dependable service. But for maximum efficiency at all times, each system must be properly maintained and serviced.

Our field service engineers are always on hand to provide emergency service, but with a Preventive Maintenance Agreement, it will seldom be necessary. You'll see:

- Improved operation with the system properly adjusted and calibrated (NBS traceability can be provided).
- Reduced operating costs due to fewer "crisis" situations.
- Increased efficiency with maintenance performed according to your schedule.
- More accurate operating budgets: You'll know your yearly maintenance cost in advance.
- Improved use of funds with less of your money invested in spare parts inventory.
- Simplified administrative procedures — one purchase order keeps the agreement in force for a full year.

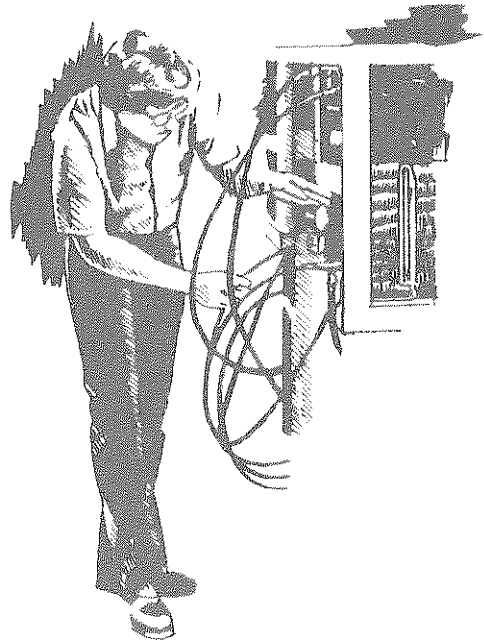

For further information about our Preventive Maintenance Agreement and how it can benefit the

operation of your plant, call us — (616) 392-1491